



 **KINDRED**

2023 COLLECTION





Contents

BROOKMORE	10
Undermount Collection	12
Topmount / Drop In Collection	20
ADA Collection	28
STEEL QUEEN	30
Undermount Collection	32
Topmount / Drop In Collection	42
Utility Collection	52
CREEMORE	62
Topmount / Drop In Collection	64
REGINOX	70
Undermount Collection	72
Topmount / Drop In Collection	78
ADA Collection	82
URBAN GRANITE	86
Undermount Collection	88
Topmount / Drop In Collection	92
WASTE DISPOSERS	96
SINK ACCESSORIES	100



What's New

Brookmore ADA Collection

Brookmore ADA sinks deliver functional design that meets unique needs without sacrificing quality or style. Made to work with easy-to-clean corners, resilient finish, and sound dampening system, these versatile dual mount sinks can be installed as either an undermount or topmount in the countertop.

See Page 28 for more details.

Bridge Cutting Board

This unique universal cutting board is made of lightweight and sustainable bamboo. The board provides an extended work area above or beside your sink. Fits over any sink opening 19" or less.

See Page 100 for our collection of sink accessories.





The Kindred Crown

A symbol of engineering excellence. The Kindred Crown reflects our passion for making your kitchen the happiest room in your home.

Our crown signifies our commitment for creating exceptional sinks that offer the reliability and durability your kitchen needs. So go ahead, host your most memorable Sunday brunches, bake your sweetest desserts, celebrate your family's greatest milestones, and tackle all the deliciously messy moments in between with confidence and ease.

It's the mark of excellence in sinks and the emblem of ease in the kitchen. Backed by a long history of making life's messy moments easier while integrating innovative design and artistry. The Kindred Crown epitomizes sinks made for real life in your home.

Give your kitchen the Kindred Crown it deserves.



Made to work

At Kindred, we put the Crowning touch on sinks that are made for real life. With a wide range of styles and sizes, Kindred offers versatile, reliable products built for hard work and made to last.

From stainless steel to natural granite, undermount models to classic drop ins, Kindred sinks suit any interior style.

Choose from our broad assortment of bowl configurations to integrate into any space in the house — kitchen, laundry, mud room, bar, or anywhere else you require a quality sink.

Whether you're outfitting a farmhouse retreat or completing a contemporary chef's kitchen, our thoughtful designs and durable engineering ensure our products are **made to work**.



Made to last

The kitchen is the heart of the home — and the sink is the heart of the kitchen.

Kindred has spent decades fine-tuning our tried and true sink designs to ensure our heartbeat only gets stronger with each passing year. You'll fall hard for their beauty and reliability, which will continue to shine thanks to our durable finishes.

Other features to make your relationship with Kindred ideal: our easy-to-clean stainless steel, our sound absorbing systems, and our drain systems — all guaranteed to maximize long-term enjoyment.

It's clear that Kindred sinks are **made to last**.





Made for ease

Eliminate complicated, frustrating, and time-consuming traditional sink installation with Kindred's EZ Torque™ installation system, available on select Kindred sink models.

Our revolutionary installation system allows you to drop and drill your sink into place, securely locking the sink to the countertop. Easier installation means enjoying your kitchen sooner.

EZ TORQUE MEANS HASSLE-FREE INSTALLATION



DROP SINK INTO THE COUNTERTOP.



TIGHTEN FASTENERS TO SECURE IN PLACE.





Pictured: BDU1831-9N

FRESH MODERN LIVING

Something new, something fresh. The perfect blend of modern design and impeccable craftsmanship. The sink is an excellent combination of bold design and functionality. The satin finish ensures a tasteful and clean aesthetic to match perfectly with any kitchen interior. Find the perfect solution for any kitchen from our wide range of models.



Brookmore



Pictured: BSU1820-9N



Pictured: BSU1832-9N-OW



BROOKMORE Undermount Sinks

CONTEMPORARY DURABLE SINKS

Create something truly unique that fits both prepping and cleaning needs by using multiple sinks from the Brookmore collection.

Our sinks are made with high quality 18-gauge stainless steel with a rich chromium content that helps shield the material from corrosion and prevents bacterial growth. The streamlined look with a striking satin finish will stand up to heavy use and retain its beauty for years.



SPACIOUS 9" DEEP BOWL

High capacity sink perfect for soaking and washing stacks of dishes.



REAR & OFFSET DRAINS

The placement of the drain has been designed to maximize bowl space.



HIGH QUALITY STAINLESS

18 gauge high quality stainless steel with exceptional resistance to staining and corrosion.

BSU1832-9N \$790.00
122.0638.276



Outside Sink Rim Dimensions: 18 1/8" FB x 32 1/2" LR
Single Bowl Dimensions: 16 1/2" FB x 30 7/8" LR x 9" DP
Minimum Cabinet Size: 36"
Gauge: 18
Corner Radius: 20mm
Finish: Satin Finish
Drain Hole Location: Rear
Sound Dampening: Sound Pads
Installation: Undermount
Shipping Weight: 22.2 lbs

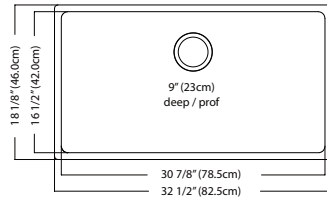

ACCESSORIES

- 1 Strainer Basket 1135
- 2 Bottom Grid BG531S
- 7 Bamboo Cutting Board MB517
- 8 Roller Mat RM55S
- 9 Colander C417P

BSU1832-9N-OW \$790.00
122.0638.277



Outside Sink Rim Dimensions: 18 1/8" FB x 32 1/2" LR
Single Bowl Dimensions: 16 1/2" FB x 30 7/8" LR x 9" DP
Minimum Cabinet Size: 36"
Gauge: 18
Corner Radius: 20mm
Finish: Satin Finish
Drain Hole Location: Rear Offset
Sound Dampening: Sound Pads
Installation: Undermount
Shipping Weight: 24.8 lbs

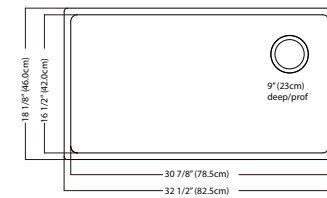

ACCESSORIES

- 1 Strainer Basket 1135
- 3 Bottom Grid BG531OS
- 7 Bamboo Cutting Board MB517
- 8 Roller Mat RM55S
- 9 Colander C417P

BSU1831-9N \$755.00
122.0637.644



Outside Sink Rim Dimensions: 18 1/8" FB x 30 1/2" LR
Single Bowl Dimensions: 16 1/2" FB x 28 15/16" LR x 9" DP
Minimum Cabinet Size: 36"
Gauge: 18
Corner Radius: 20mm
Finish: Satin Finish
Drain Hole Location: Rear
Sound Dampening: Sound Pads
Installation: Undermount
Shipping Weight: 23 lbs

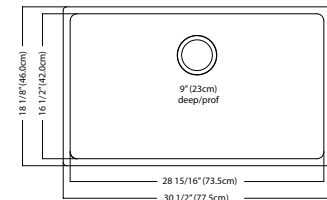

ACCESSORIES

- 1 Strainer Basket 1135
- 4 Bottom Grid BG529S
- 7 Bamboo Cutting Board MB517
- 8 Roller Mat RM55S
- 9 Colander C417P

BSU1825-9N \$700.00
122.0637.642



Outside Sink Rim Dimensions: 18 1/8" FB x 24 5/8" LR
Single Bowl Dimensions: 16 1/2" FB x 23" LR x 9" DP
Minimum Cabinet Size: 30"
Gauge: 18
Corner Radius: 20mm
Finish: Satin Finish
Drain Hole Location: Rear
Sound Dampening: Sound Pads
Installation: Undermount
Shipping Weight: 18.3 lbs

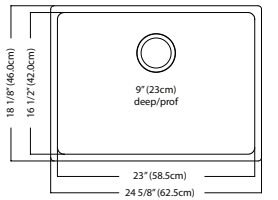

ACCESSORIES

- 1 Strainer Basket 1135
- 5 Bottom Grid BG523S
- 7 Bamboo Cutting Board MB517
- 8 Roller Mat RM55S
- 9 Colander C417P

BSU1820-9N \$655.00
122.0637.640



Outside Sink Rim Dimensions: 18 1/8" FB x 19 1/2" LR
Single Bowl Dimensions: 16 1/2" FB x 17 15/16" LR x 9" DP
Minimum Cabinet Size: 24"
Gauge: 18
Corner Radius: 20mm
Finish: Satin Finish
Drain Hole Location: Rear
Sound Dampening: Sound Pads
Installation: Undermount
Shipping Weight: 15.8 lbs

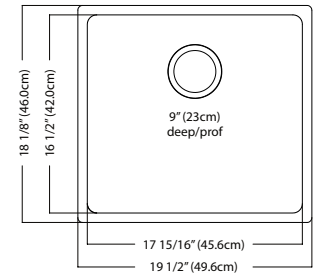

ACCESSORIES

- 1 Strainer Basket 1135
- 6 Bottom Grid BG518S
- 7 Bamboo Cutting Board MB517
- 8 Roller Mat RM55S
- 9 Colander C417P

OPTIONAL ACCESSORIES



- 1 Strainer Basket 1135
112.0040.566
\$25.00
- 2 Bottom Grid BG531S
112.0624.284
\$190.00
- 3 Bottom Grid BG531OS
112.0624.285
\$190.00
- 4 Bottom Grid BG529S
112.0624.283
\$180.00
- 5 Bottom Grid BG523S
112.0624.286
\$170.00



- 6 Bottom Grid BG518S
112.0624.287
\$165.00
- 7 Bamboo Cutting Board MB517
112.0624.298
\$160.00
- 8 Roller Mat RM55S
112.0058.824
\$175.00
- 9 Colander C417P
112.0538.950
\$75.00

BSU1816-9N \$625.00
122.0637.638



Outside Sink Rim Dimensions: 18 1/8" FB x 15 9/16" LR
Single Bowl Dimensions: 16 1/2" FB x 13 15/16" LR x 9" DP
Minimum Cabinet Size: 21"
Gauge: 18
Corner Radius: 20mm
Finish: Satin Finish
Drain Hole Location: Rear
Sound Dampening: Sound Pads
Installation: Undermount
Shipping Weight: 14 lbs

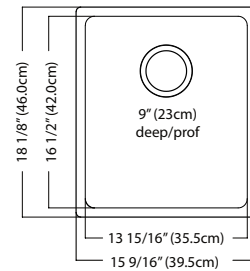

ACCESSORIES

- 1 Strainer Basket 1135
- 2 Bottom Grid BG514S
- 6 Bamboo Cutting Board MB517
- 7 Roller Mat RM55S
- 8 Colander C417P

BSU1812-8N \$595.00
122.0637.636



Outside Sink Rim Dimensions: 18 1/8" FB x 11 9/16" LR
Single Bowl Dimensions: 16 1/2" FB x 10" LR x 7 7/8" DP
Minimum Cabinet Size: 18"
Gauge: 18
Corner Radius: 20mm
Finish: Satin Finish
Drain Hole Location: Rear
Sound Dampening: Sound Pads
Installation: Undermount
Shipping Weight: 11.5 lbs

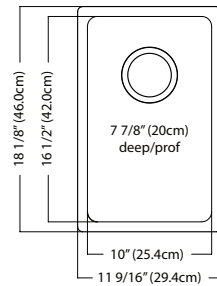

ACCESSORIES

- 1 Strainer Basket 1135
- 3 Bottom Grid BG510S
- 6 Bamboo Cutting Board MB517
- 8 Colander C417P

BCU1836R-9N \$960.00
122.0638.275



Outside Sink Rim Dimensions: 18 1/8" FB x 35 9/16" LR
Large Bowl Dimensions: 16 1/2" FB x 23" LR x 9" DP
Small Bowl Dimensions: 16 1/2" FB x 10" LR x 7 7/8" DP
Minimum Cabinet Size: 39"
Gauge: 18
Corner Radius: 20mm
Finish: Satin Finish
Drain Hole Location: Rear
Sound Dampening: Sound Pads
Installation: Undermount
Shipping Weight: 27.2 lbs

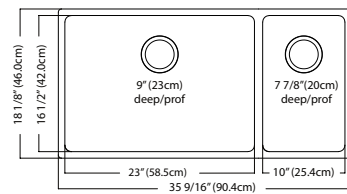

ACCESSORIES

- 1 Strainer Basket 1135
- 3 Bottom Grid BG510S
- 4 Bottom Grid BG523S
- 6 Bamboo Cutting Board MB517
- 7 Roller Mat RM55S
- 8 Colander C417P

BCU1835R-9N \$935.00
122.0638.274



Outside Sink Rim Dimensions: 18 1/8" FB x 34 1/2" LR
Large Bowl Dimensions: 16 1/2" FB x 17 15/16" LR x 9" DP
Small Bowl Dimensions: 16 1/2" FB x 13 15/16" LR x 9" DP
Minimum Cabinet Size: 39"
Gauge: 18
Corner Radius: 20mm
Finish: Satin Finish
Drain Hole Location: Rear
Sound Dampening: Sound Pads
Installation: Undermount
Shipping Weight: 26.7 lbs

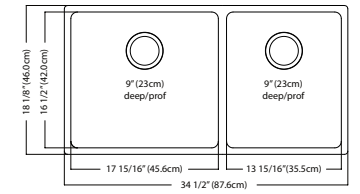

ACCESSORIES

- 1 Strainer Basket 1135
- 2 Bottom Grid BG514S
- 5 Bottom Grid BG518S
- 6 Bamboo Cutting Board MB517
- 7 Roller Mat RM55S
- 8 Colander C417P

BCU1831R-9N \$915.00
122.0637.629



Outside Sink Rim Dimensions: 18 1/8" FB x 30 1/2" LR
Large Bowl Dimensions: 16 1/2" FB x 17 15/16" LR x 9" DP
Small Bowl Dimensions: 16 1/2" FB x 10" LR x 7 7/8" DP
Minimum Cabinet Size: 36"
Gauge: 18
Corner Radius: 20mm
Finish: Satin Finish
Drain Hole Location: Rear
Sound Dampening: Sound Pads
Installation: Undermount
Shipping Weight: 23.4 lbs

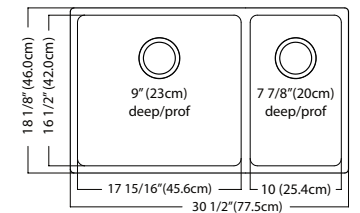

ACCESSORIES

- 1 Strainer Basket 1135
- 3 Bottom Grid BG510S
- 5 Bottom Grid BG518S
- 6 Bamboo Cutting Board MB517
- 7 Roller Mat RM55S
- 8 Colander C417P

OPTIONAL ACCESSORIES

- 1 Strainer Basket 1135
112.0040.566
\$25.00
- 2 Bottom Grid BG514S
112.0624.290
\$140.00
- 3 Bottom Grid BG510S
112.0624.292
\$135.00
- 4 Bottom Grid BG523S
112.0624.286
\$170.00
- 5 Bottom Grid BG518S
112.0624.287
\$165.00
- 6 Bamboo Cutting Board MB517
112.0624.298
\$160.00
- 7 Roller Mat RM55S
112.0058.824
\$175.00
- 8 Colander C417P
112.0538.950
\$75.00

BCU1827R-9N \$885.00
122.0637.627



Outside Sink Rim Dimensions: 18 1/8" FB x 26 9/16" LR
Large Bowl Dimensions: 16 1/2" FB x 13 15/16" LR x 9" DP
Small Bowl Dimensions: 16 1/2" FB x 10" LR x 7 7/8" DP
Minimum Cabinet Size: 30"
Gauge: 18
Corner Radius: 20mm
Finish: Satin Finish
Drain Hole Location: Rear
Sound Dampening: Sound Pads
Installation: Undermount
Shipping Weight: 22.2 lbs

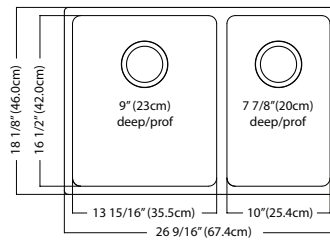

ACCESSORIES

- 1 Strainer Basket 1135
- 2 Bottom Grid BG514S
- 3 Bottom Grid BG510S
- 4 Bamboo Cutting Board MB517
- 5 Roller Mat RM55S
- 6 Colander C417P

BDU1831-9N \$820.00
122.0637.634



Outside Sink Rim Dimensions: 18 1/8" FB x 30 1/2" LR
Equal Size Bowl Dimensions: 16 1/2" FB x 13 15/16" LR x 9" DP
Minimum Cabinet Size: 36"
Gauge: 18
Corner Radius: 20mm
Finish: Satin Finish
Drain Hole Location: Rear
Sound Dampening: Sound Pads
Installation: Undermount
Shipping Weight: 24.8 lbs

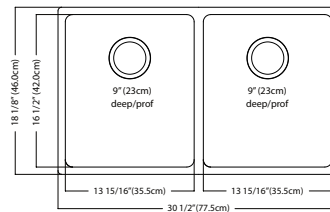

ACCESSORIES

- 1 Strainer Basket 1135
- 2 Bottom Grid BG514S
- 4 Bamboo Cutting Board MB517
- 5 Roller Mat RM55S
- 6 Colander C417P

BTU1841-9N \$1,070.00
122.0638.278



Outside Sink Rim Dimensions: 18 1/8" FB x 41 1/2" LR
Equal Bowl Dimensions: 16 1/2" FB x 13 15/16" LR x 9" DP
Small Bowl Dimensions: 16 1/2" FB x 10" LR x 7 7/8" DP
Minimum Cabinet Size: 45"
Gauge: 18
Corner Radius: 20mm
Finish: Satin Finish
Drain Hole Location: Rear
Sound Dampening: Sound Pads
Installation: Undermount
Shipping Weight: 33 lbs

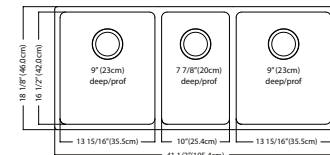

ACCESSORIES

- 1 Strainer Basket 1135
- 2 Bottom Grid BG514S
- 3 Bottom Grid BG510S
- 4 Bamboo Cutting Board MB517
- 5 Roller Mat RM55S
- 6 Colander C417P



OPTIONAL ACCESSORIES



1 Strainer Basket 1135
112.0040.566
\$25.00



2 Bottom Grid BG514S
112.0624.290
\$140.00



3 Bottom Grid BG510S
112.0624.292
\$135.00



4 Bamboo Cutting Board MB517
112.0624.298
\$160.00



5 Roller Mat RM55S
112.0058.824
\$175.00



6 Colander C417P
112.0538.950
\$75.00



Pictured: BSL2233-9-1N



Pictured: BSL2225-9-1N



BROOKMORE
Topmount / Drop In Sinks

REFINE, ENHANCE, UPGRADE

It's easy to change the look of any kitchen and create something that feels completely new without remodeling the entire space.

Our revolutionary EZ Torque™ installation system is a simplified fastener process that allows you to install the sink in just a few simple steps. Easier installation means enjoying your kitchen sooner.



SPACIOUS 9" DEEP BOWL

High capacity sink perfect for soaking and washing stacks of dishes.



EZ TORQUE INSTALLATION

Simplified fastener system and drop-and-drill process make this one of the industry's quickest sinks to install.



REAR & OFFSET DRAINS

The placement of the drain has been designed to maximize bowl space.

BSL2233-9-4N (4 faucet holes) \$760.00
101.0637.032

BSL2233-9-3N (3 faucet holes)
101.0637.030

BSL2233-9-1N (1 faucet hole)
101.0637.028



Outside Sink Rim Dimensions: 22" FB x 32 7/8" LR
Single Bowl Dimensions: 16 1/2" FB x 30 7/8" LR x 9" DP
Minimum Cabinet Size: 36"
Gauge: 18
Corner Radius: 20mm
Finish: Satin Finish
Drain Hole Location: Rear
Sound Dampening: Sound Pads
Installation: Topmount / Drop In
Shipping Weight: 23 lbs

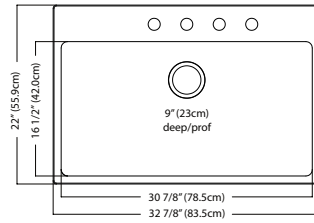

ACCESSORIES

- 1 Strainer Basket 1135
- 2 Bottom Grid BG531S
- 6 Bamboo Cutting Board MB517
- 7 Roller Mat RM55S
- 8 Colander C417P



BSL2225-9-4N (4 faucet holes) \$710.00
101.0637.027

BSL2225-9-3N (3 faucet holes)
101.0637.026

BSL2225-9-1N (1 faucet hole)
101.0637.025



Outside Sink Rim Dimensions: 22" FB x 25" LR
Single Bowl Dimensions: 16 1/2" FB x 23" LR x 9" DP
Minimum Cabinet Size: 27"
Gauge: 18
Corner Radius: 20mm
Finish: Satin Finish
Drain Hole Location: Rear
Sound Dampening: Sound Pads
Installation: Topmount / Drop In
Shipping Weight: 19.2 lbs

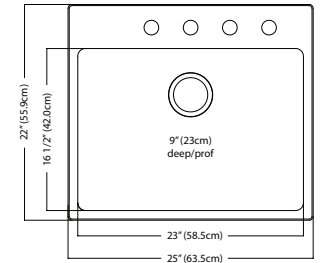

ACCESSORIES

- 1 Strainer Basket 1135
- 5 Bottom Grid BG523S
- 6 Bamboo Cutting Board MB517
- 7 Roller Mat RM55S
- 8 Colander C417P



BSL2233-9-4N-OW (4 faucet holes) \$760.00
101.0637.033

BSL2233-9-3N-OW (3 faucet holes)
101.0637.031

BSL2233-9-1N-OW (1 faucet hole)
101.0637.029



Outside Sink Rim Dimensions: 22" FB x 32 7/8" LR
Single Bowl Dimensions: 16 1/2" FB x 30 7/8" LR x 9" DP
Minimum Cabinet Size: 36"
Gauge: 18
Corner Radius: 20mm
Finish: Satin Finish
Drain Hole Location: Rear offset
Sound Dampening: Sound Pads
Installation: Topmount / Drop In
Shipping Weight: 23 lbs

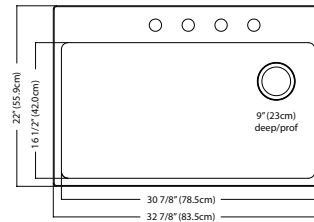

ACCESSORIES

- 1 Strainer Basket 1135
- 3 Bottom Grid BG531OS
- 6 Bamboo Cutting Board MB517
- 7 Roller Mat RM55S
- 8 Colander C417P



BSL2125-9-4N (4 faucet holes) \$685.00
101.0636.987

BSL2125-9-3N (3 faucet holes)
101.0636.985

BSL2125-9-1N (1 faucet hole)
101.0636.983



Outside Sink Rim Dimensions: 20 7/8" FB x 25" LR
Single Bowl Dimensions: 16 1/2" FB x 23" LR x 9" DP
Minimum Cabinet Size: 27"
Gauge: 18
Corner Radius: 20mm
Finish: Satin Finish
Drain Hole Location: Rear
Sound Dampening: Sound Pads
Installation: Topmount / Drop In
Shipping Weight: 18.8 lbs

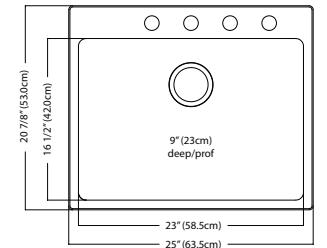

ACCESSORIES

- 1 Strainer Basket 1135
- 5 Bottom Grid BG523S
- 6 Bamboo Cutting Board MB517
- 7 Roller Mat RM55S
- 8 Colander C417P



BSL2131-9-4N (4 faucet holes) \$735.00
101.0636.993

BSL2131-9-3N (3 faucet holes)
101.0636.991

BSL2131-9-1N (1 faucet hole)
101.0636.989



Outside Sink Rim Dimensions: 20 7/8" FB x 30 7/8" LR
Single Bowl Dimensions: 16 1/2" FB x 28 15/16" LR x 9" DP
Minimum Cabinet Size: 33"
Gauge: 18
Corner Radius: 20mm
Finish: Satin Finish
Drain Hole Location: Rear
Sound Dampening: Sound Pads
Installation: Topmount / Drop In
Shipping Weight: 23.2 lbs

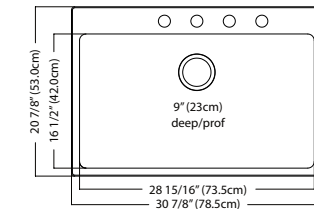

ACCESSORIES

- 1 Strainer Basket 1135
- 4 Bottom Grid BG529S
- 6 Bamboo Cutting Board MB517
- 7 Roller Mat RM55S
- 8 Colander C417P



OPTIONAL ACCESSORIES



- 1 Strainer Basket 1135
112.0040.566
\$25.00
- 2 Bottom Grid BG531S
112.0624.284
\$190.00
- 3 Bottom Grid BG531OS
112.0624.285
\$190.00
- 4 Bottom Grid BG529S
112.0624.283
\$180.00



- 5 Bottom Grid BG523S
112.0624.286
\$170.00
- 6 Bamboo Cutting Board MB517
112.0624.298
\$160.00
- 7 Roller Mat RM55S
112.0058.824
\$175.00
- 8 Colander C417P
112.0538.950
\$75.00

BSL2120-9-4N (4 faucet holes) \$595.00

101.0636.981

BSL2120-9-3N (3 faucet holes)

101.0636.979

BSL2120-9-1N (1 faucet hole)

101.0636.977



Outside Sink Rim Dimensions: 20 7/8" FB x 19 15/16" LR
Single Bowl Dimensions: 16 1/2" FB x 17 15/16" LR x 9" DP
Minimum Cabinet Size: 24"
Gauge: 18
Corner Radius: 20mm
Finish: Satin Finish
Drain Hole Location: Rear
Sound Dampening: Sound Pads
Installation: Topmount / Drop In
Shipping Weight: 15.6 lbs

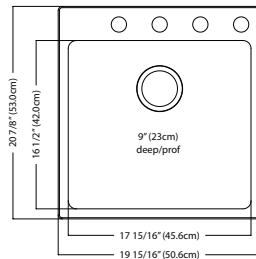

ACCESSORIES

- 1 Strainer Basket 1135
- 2 Bottom Grid BG518S
- 6 Bamboo Cutting Board MB517
- 7 Roller Mat RM55S
- 8 Colander C417P



BCL2127R-9-4N (4 faucet holes) \$950.00

101.0636.947

BCL2127R-9-3N (3 faucet holes)

101.0636.945

BCL2127R-9-1N (1 faucet hole)

101.0636.943



Outside Sink Rim Dimensions: 20 7/8" FB x 26 15/16" LR
Large Bowl Dimensions: 16 1/2" FB x 13 15/16" LR x 9" DP
Small Bowl Dimensions: 16 1/2" FB x 10" LR x 7 7/8" DP
Minimum Cabinet Size: 30"
Gauge: 18
Corner Radius: 20mm
Finish: Satin Finish
Drain Hole Location: Rear
Sound Dampening: Sound Pads
Installation: Topmount / Drop In
Shipping Weight: 22.2 lbs

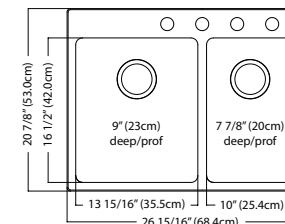

ACCESSORIES

- 1 Strainer Basket 1135
- 3 Bottom Grid BG514S
- 4 Bottom Grid BG510S
- 6 Bamboo Cutting Board MB517
- 7 Roller Mat RM55S
- 8 Colander C417P



BSL2116-9-3N (3 faucet holes) \$565.00

101.0636.975

BSL2116-9-1N (1 faucet hole)

101.0636.973



Outside Sink Rim Dimensions: 20 7/8" FB x 15 15/16" LR
Single Bowl Dimensions: 16 1/2" FB x 13 15/16" LR x 9" DP
Minimum Cabinet Size: 18"
Gauge: 18
Corner Radius: 20mm
Finish: Satin Finish
Drain Hole Location: Rear
Sound Dampening: Sound Pads
Installation: Topmount / Drop In
Shipping Weight: 14.7 lbs

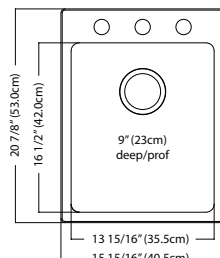

ACCESSORIES

- 1 Strainer Basket 1135
- 3 Bottom Grid BG514S
- 6 Bamboo Cutting Board MB517
- 7 Roller Mat RM55S
- 8 Colander C417P



BDL2233-9-4N (4 faucet holes) \$865.00

101.0637.022

BDL2233-9-3N (3 faucet holes)

101.0637.023

BDL2233-9-1N (1 faucet hole)

101.0637.024



Outside Sink Rim Dimensions: 22" FB x 32 7/8" LR
Equal Size Bowl Dimensions: 16 1/2" FB x 14 15/16" LR x 9" DP
Minimum Cabinet Size: 36"
Gauge: 18
Corner Radius: 20mm
Finish: Satin Finish
Drain Hole Location: Rear
Sound Dampening: Sound Pads
Installation: Topmount / Drop In
Shipping Weight: 27 lbs

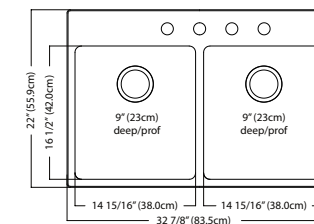

ACCESSORIES

- 1 Strainer Basket 1135
- 5 Bottom Grid BG515S
- 6 Bamboo Cutting Board MB517
- 7 Roller Mat RM55S
- 8 Colander C417P



BCL2131R-9-4N (4 faucet holes) \$1,015.00

101.0636.953

BCL2131R-9-3N (3 faucet holes)

101.0636.951

BCL2131R-9-1N (1 faucet hole)

101.0636.949



Outside Sink Rim Dimensions: 20 7/8" FB x 30 7/8" LR
Large Bowl Dimensions: 16 1/2" FB x 17 15/16" LR x 9" DP
Small Bowl Dimensions: 16 1/2" FB x 10" LR x 7 7/8" DP
Minimum Cabinet Size: 33"
Gauge: 18
Corner Radius: 20mm
Finish: Satin Finish
Drain Hole Location: Rear
Sound Dampening: Sound Pads
Installation: Topmount / Drop In
Shipping Weight: 24.2 lbs

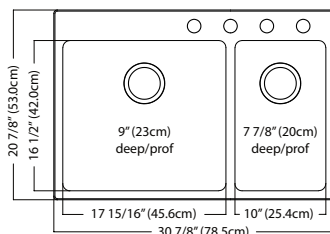

ACCESSORIES

- 1 Strainer Basket 1135
- 2 Bottom Grid BG518S
- 4 Bottom Grid BG510S
- 6 Bamboo Cutting Board MB517
- 7 Roller Mat RM55S
- 8 Colander C417P



OPTIONAL ACCESSORIES



1 Strainer Basket 1135
112.0040.566
\$25.00



2 Bottom Grid BG518S
112.0624.287
\$165.00



3 Bottom Grid BG514S
112.0624.290
\$140.00



4 Bottom Grid BG510S
112.0624.292
\$135.00



5 Bottom Grid BG515S
112.0624.288
\$150.00



6 Bamboo Cutting Board MB517
112.0624.298
\$160.00



7 Roller Mat RM55S
112.0058.824
\$175.00



8 Colander C417P
112.0538.950
\$75.00

BDL2131-9-4N (4 faucet holes) \$790.00

101.0636.966

BDL2131-9-3N (3 faucet holes)

101.0636.964

BDL2131-9-1N (1 faucet hole)

101.0636.962



Outside Sink Rim Dimensions: 20 7/8" FB x 30 7/8" LR
 Equal Size Bowl Dimensions: 16 1/2" FB x 13 15/16" LR x 9" DP
 Minimum Cabinet Size: 33"
 Gauge: 18
 Corner Radius: 20mm
 Finish: Satin Finish
 Drain Hole Location: Rear
 Sound Dampening: Sound Pads
 Installation: Topmount / Drop In
 Shipping Weight: 24.2 lbs

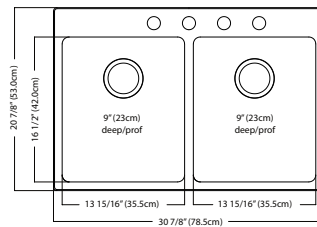

ACCESSORIES

- 1** Strainer Basket 1135
- 2** Bottom Grid BG514S
- 3** Bamboo Cutting Board MB517
- 4** Roller Mat RM55S
- 5** Colander C417P



OPTIONAL ACCESSORIES



1 Strainer Basket
1135
112.0040.566
\$25.00



2 Bottom Grid
BG514S
112.0624.290
\$140.00



3 Bamboo Cutting Board
MB517
112.0624.298
\$160.00



4 Roller Mat
RM55S
112.0058.824
\$175.00



5 Colander
C417P
112.0538.950
\$75.00



Pictured: BSL2131-9-1N



Pictured: BSL2233-ADA-1N

BROOKMORE
ADA Sinks

FUNCTIONAL DESIGN

Brookmore ADA sinks allow everyone to have a sleek, minimal radius sink for their modern or transitional kitchen. These sinks are made from top quality 18-gauge stainless steel and can handle every kitchen chore with ease.



ACCESSIBLE DESIGN

Shallow bowl depth and rear drain placement allows for sufficient knee space when sink is used in seated position.



EZ TORQUE INSTALLATION

Simplified fastener system and drop-and-drill process make this one of the industry's quickest sinks to install.



REAR DRAINS

The placement of the drain has been designed to maximize bowl space.

NEW

BSL2225-ADA-1N (1 faucet hole) \$710.00
101.0689.854



Outside Sink Rim Dimensions: 22" FB x 25" LR
Single Bowl Dimensions: 16 1/2" FB x 23" LR x 5 3/8" DP
Minimum Cabinet Size: 27"
Gauge: 18
Corner Radius: 20mm
Finish: Satin Finish
Drain Hole Location: Rear
Sound Dampening: Sound Pads
Installation: Dualmount
Shipping Weight: 19.2 lbs

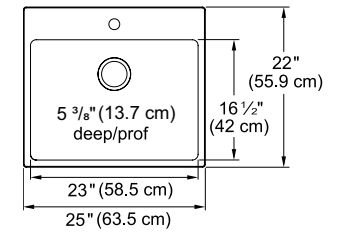

ACCESSORIES

- 1 Strainer Basket 1135
- 3 Bottom Grid BG523S
- 4 Bamboo Cutting Board MB517
- 5 Roller Mat RM55S
- 6 Colander C417P



NEW

BSL2233-ADA-1N (1 faucet hole) \$760.00
101.0689.856



Outside Sink Rim Dimensions: 22" FB x 32 7/8" LR
Single Bowl Dimensions: 16 1/2" FB x 30 7/8" LR x 5 3/8" DP
Minimum Cabinet Size: 36"
Gauge: 18
Corner Radius: 20mm
Finish: Satin Finish
Drain Hole Location: Rear
Sound Dampening: Sound Pads
Installation: Dualmount
Shipping Weight: 23 lbs

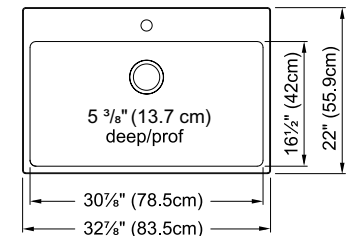

ACCESSORIES

- 1 Strainer Basket 1135
- 2 Bottom Grid BG531S
- 4 Bamboo Cutting Board MB517
- 5 Roller Mat RM55S
- 6 Colander C417P



OPTIONAL ACCESSORIES

- 1 Strainer Basket 1135 \$25.00
- 2 Bottom Grid BG531S \$190.00
- 3 Bottom Grid BG523S \$170.00
- 4 Bamboo Cutting Board MB517 \$160.00
- 5 Roller Mat RM55S \$175.00
- 6 Colander C417P \$75.00

* ADA Compliant: Product is compliant with the American Disabilities Act when properly installed



Pictured: QSUA1933-8N

THE CROWNING TOUCH

Trademarked in 1954, our Steel Queen sinks epitomize the Kindred Crown promise. Boasting innovative design details fine-tuned over decades, the Steel Queen collection is synonymous with our Kindred commitment to quality.

Meet our Queen, proudly bearing the Kindred Crown for decades.



Steel Queen Undermount

Pictured: QDUA1831-8N



Steel Queen Undermount

Pictured: QSU1113-6N



STEEL QUEEN
Undermount Sinks

CLASSICALLY RELIABLE

Kindred Steel Queen sinks offer versatile durability in a wide variety of styles.

These classic sinks seamlessly complement and accentuate solid-surface countertops anywhere in the house. Equipped with a durable finish to ensure your sink will shine for years to come, even through the growing demands of everyday life.



UNDERMOUNT INSTALLATION
 Seamless profile brings sleek style to any kitchen.



ULTRA QUIET
 Sound dampening system that keeps your kitchen clear of excess noise from running water and disposal vibration.



STYLE & VERSATILITY
 Choose from a wide range of shapes, sizes and styles to suit any kitchen.

QSU1933-8N \$510.00
122.0620.085



Outside Sink Rim Dimensions: 18 3/4" FB x 32 3/4" LR
Single Bowl Dimensions: 17" FB x 31" LR x 8" DP
Minimum Cabinet Size: 36"
Gauge: 20
Corner Radius: 50mm
Finish: Satin Finished Bowl with Silk Finished Rim
Drain Hole Location: Rear
Sound Dampening: Undercoating
Installation: Undermount
Shipping Weight: 17.6 lbs

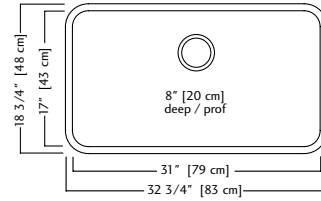

ACCESSORIES

- 1** Strainer Basket 1135
- 2** Bottom Grid BGA3117S
- 7** Drainer Basket DBR10S
- 8** Bamboo Bridge Cutting Board 112.0654.749

QSU1831-8N \$475.00
122.0620.103



Outside Sink Rim Dimensions: 17 3/4" FB x 30 3/4" LR
Single Bowl Dimensions: 16" FB x 29" LR x 8" DP
Minimum Cabinet Size: 36"
Gauge: 20
Corner Radius: 50mm
Finish: Satin Finished Bowl with Silk Finished Rim
Drain Hole Location: Rear
Sound Dampening: Undercoating
Installation: Undermount
Shipping Weight: 13.5 lbs

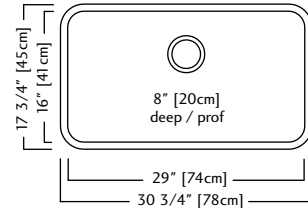

ACCESSORIES

- 1** Strainer Basket 1135
- 3** Bottom Grid BG240S
- 7** Drainer Basket DBR10S
- 8** Bamboo Bridge Cutting Board 112.0654.749

QSU1925-8N \$430.00
122.0169.261



Outside Sink Rim Dimensions: 18 3/4" FB x 24 3/4" LR
Single Bowl Dimensions: 17" FB x 23" LR x 8" DP
Minimum Cabinet Size: 30"
Gauge: 20
Corner Radius: 50mm
Finish: Satin Finished Bowl with Silk Finished Rim
Drain Hole Location: Rear
Sound Dampening: Undercoating
Installation: Undermount
Shipping Weight: 14.5 lbs

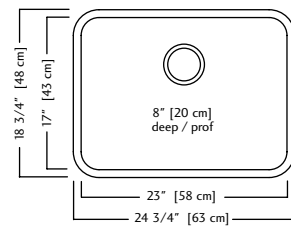

ACCESSORIES

- 1** Strainer Basket 1135
- 4** Bottom Grid BGA2317S
- 7** Drainer Basket DBR10S
- 8** Bamboo Bridge Cutting Board 112.0654.749

QSU1922-8N \$435.00
122.0651.372



Outside Sink Rim Dimensions: 18 3/4" FB x 21 3/4" LR
Single Bowl Dimensions: 17" FB x 20" LR x 8" DP
Minimum Cabinet Size: 27"
Gauge: 20
Corner Radius: 50mm
Finish: Satin Finished Bowl with Silk Finished Rim
Drain Hole Location: Rear
Sound Dampening: Undercoating
Installation: Undermount
Shipping Weight: 12.1 lbs

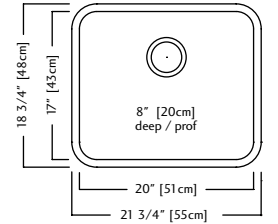

ACCESSORIES

- 1** Strainer Basket 1135
- 5** Bottom Grid BG14S
- 7** Drainer Basket DBR10S
- 8** Bamboo Bridge Cutting Board 112.0654.749

QSU1917-8N \$390.00
122.0620.087



Outside Sink Rim Dimensions: 18 3/4" FB x 16 3/4" LR
Single Bowl Dimensions: 17" FB x 15" LR x 8" DP
Minimum Cabinet Size: 21"
Gauge: 20
Corner Radius: 50mm
Finish: Satin Finished Bowl with Silk Finished Rim
Drain Hole Location: Rear
Sound Dampening: Undercoating
Installation: Undermount
Shipping Weight: 9.2 lbs

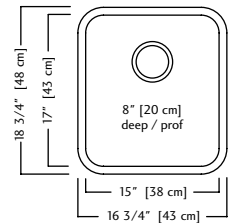

ACCESSORIES

- 1** Strainer Basket 1135
- 6** Bottom Grid BGA1517S
- 7** Drainer Basket DBR10S
- 8** Bamboo Bridge Cutting Board 112.0654.749

OPTIONAL ACCESSORIES



- 1** Strainer Basket 1135
112.0040.566
\$25.00
- 2** Bottom Grid BGA3117S
112.0174.878
\$190.00
- 3** Bottom Grid BG240S
112.0204.314
\$180.00
- 4** Bottom Grid BGA2317S
112.0174.875
\$165.00



- 5** Bottom Grid BG14S
112.0486.240
\$125.00
- 6** Bottom Grid BGA1517S
112.0174.872
\$125.00
- 7** Drainer Basket DBR10S
112.0044.784
\$135.00
- 8** Bamboo Bridge Cutting Board 112.0654.749
\$150.00

QSU1813-7N \$420.00
122.0620.093



Outside Sink Rim Dimensions: 18 1/8" FB x 12 3/4" LR
Single Bowl Dimensions: 16" FB x 10 5/8" LR x 7" DP
Minimum Cabinet Size: 21"
Gauge: 18
Corner Radius: 70mm
Finish: Silk Finished Bowl with Silk Finished Rim
Drain Hole Location: Rear
Sound Dampening: Sound Pads & Undercoating
Installation: Undermount
Shipping Weight: 9.1 lbs

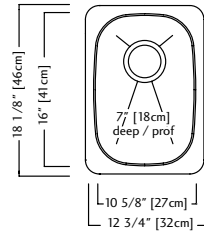

ACCESSORIES

- 1 Strainer Basket 1135
- 4 Bottom Grid BG35S
- 6 Bamboo Bridge Cutting Board 112.0654.749

QSU1816-8N \$295.00
122.0620.098



Outside Sink Rim Dimensions: 17 3/4" FB x 15 3/4" LR
Single Bowl Dimensions: 16" FB x 14" LR x 8" DP
Minimum Cabinet Size: 21"
Gauge: 20
Corner Radius: 50mm
Finish: Satin Finished Bowl with Silk Finished Rim
Drain Hole Location: Rear
Sound Dampening: Undercoating
Installation: Undermount
Shipping Weight: 7.1 lbs



ACCESSORIES

- 1 Strainer Basket 1135
- 3 Bottom Grid BG10S
- 5 Drainer Basket DBR10S
- 6 Bamboo Bridge Cutting Board 112.0654.749



Outside Sink Rim Dimensions: 17 3/4" FB x 19 3/4" LR
Single Bowl Dimensions: 16" FB x 18" LR x 8" DP
Minimum Cabinet Size: 24"
Gauge: 20
Corner Radius: 50mm
Finish: Satin Finished Bowl with Silk Finished Rim
Drain Hole Location: Rear
Sound Dampening: Undercoating
Installation: Undermount
Shipping Weight: 9.3 lbs

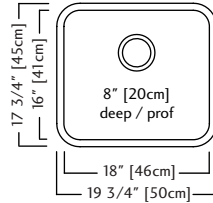

ACCESSORIES

- 1 Strainer Basket 1135
- 2 Bottom Grid BG11S
- 5 Drainer Basket DBR10S
- 6 Bamboo Bridge Cutting Board 112.0654.749

QSU1820-8N \$320.00
122.0620.086



Outside Sink Rim Dimensions: 12 3/4" FB x 14 3/4" LR
Single Bowl Dimensions: 11" FB x 13" LR x 6" DP
Minimum Cabinet Size: 18"
Gauge: 20
Corner Radius: 50mm
Finish: Satin Finished Bowl with Silk Finished Rim
Drain Hole Location: Center
Sound Dampening: Undercoating
Installation: Undermount
Shipping Weight: 6 lbs

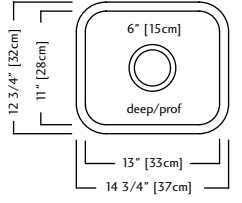

ACCESSORIES

- 1 Strainer Basket 1135
- 6 Bamboo Bridge Cutting Board 112.0654.749



Outside Sink Rim Dimensions: 15 3/4" FB x 15 3/4" LR
Single Bowl Dimensions: 14" FB x 14" LR x 6" DP
Minimum Cabinet Size: 21"
Gauge: 20
Corner Radius: 50mm
Finish: Satin Finished Bowl with Silk Finished Rim
Drain Hole Location: Rear
Sound Dampening: Undercoating
Installation: Undermount
Shipping Weight: 5.5 lbs

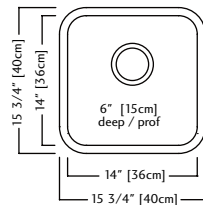

ACCESSORIES

- 1 Strainer Basket 1135
- 6 Bamboo Bridge Cutting Board 112.0654.749

OPTIONAL ACCESSORIES

- 1 Strainer Basket 1135 \$25.00
- 2 Bottom Grid BG11S \$120.00
- 3 Bottom Grid BG10S \$120.00
- 4 Bottom Grid BG35S \$110.00
- 5 Drainer Basket DBR10S \$135.00
- 6 Bamboo Bridge Cutting Board 112.0654.749 \$150.00

QSU1113-6N \$210.00
101.0620.260



Outside Sink Rim Dimensions: 11" FB x 13 3/8" LR
Single Bowl Dimensions: 9 1/4" FB x 11 5/8" LR x 6" DP
Minimum Cabinet Size: 18"
Gauge: 20
Corner Radius: 50mm
Finish: Satin Finished Bowl with Silk Finished Rim
Drain Hole Location: Center
Sound Dampening: Undercoating
Installation: Undermount
Shipping Weight: 3.8 lbs

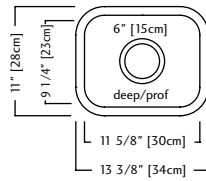

ACCESSORIES

- 2 Strainer Basket 1135
- 9 Bamboo Bridge Cutting Board 112.0654.749

QCU1933R-9N \$790.00
122.0187.518



Outside Sink Rim Dimensions: 18 3/4" FB x 32 7/8" LR
Large Bowl Dimensions: 17" FB x 18" LR x 9" DP
Small Bowl Dimensions: 17" FB x 12" LR x 8" DP
Minimum Cabinet Size: 36"
Gauge: 18
Corner Radius: 50mm
Finish: Silk Finished Bowls with Silk Finished Rim
Drain Hole Location: Rear
Sound Dampening: Sound Pads & Undercoating
Installation: Undermount
Shipping Weight: 26.4 lbs

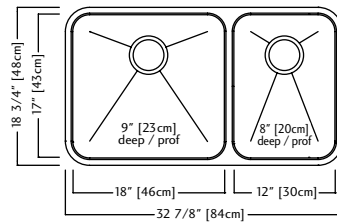

ACCESSORIES

- 2 Strainer Basket 1135
- 3 Bottom Grid BGA1817S
- 4 Bottom Grid BGA1217S
- 8 Drainer Basket DBR10S
- 9 Bamboo Bridge Cutting Board 112.0654.749

QCUA1933R-8N \$685.00
122.0620.084



Outside Sink Rim Dimensions: 18 3/4" FB x 32 7/8" LR
Large Bowl Dimensions: 17" FB x 18" LR x 8" DP
Small Bowl Dimensions: 17" FB x 12" LR x 7" DP
Minimum Cabinet Size: 36"
Gauge: 20
Corner Radius: 50mm
Finish: Satin Finished Bowls with Silk Finished Rim
Drain Hole Location: Rear
Sound Dampening: Undercoating
Installation: Undermount
Shipping Weight: 17.2 lbs

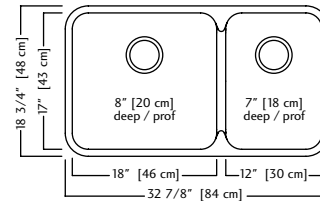

ACCESSORIES

- 2 Strainer Basket 1135
- 3 Bottom Grid BGA1817S
- 4 Bottom Grid BGA1217S
- 8 Drainer Basket DBR10S
- 9 Bamboo Bridge Cutting Board 112.0654.749

QCUA1831R-8N (as shown) \$675.00
122.0620.095

QCUA1831L-8N (small bowl left)
122.0620.096



Outside Sink Rim Dimensions: 17 3/4" FB x 30 7/8" LR
Large Bowl Dimensions: 16" FB x 18" LR x 8" DP
Small Bowl Dimensions: 16" FB x 10" LR x 7" DP
Minimum Cabinet Size: 36"
Gauge: 20
Corner Radius: 50mm
Finish: Satin Finished Bowls with Silk Finished Rim
Drain Hole Location: Rear
Sound Dampening: Undercoating
Installation: Undermount
Shipping Weight: 17 lbs

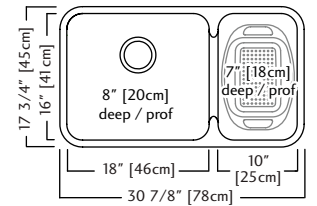

ACCESSORIES

- 1 Colander CA1W **Included**
- 2 Strainer Basket 1135
- 5 Bottom Grid BG13S
- 6 Bottom Grid BG11S
- 8 Drainer Basket DBR10S
- 9 Bamboo Bridge Cutting Board 112.0654.749

QCUA1827R-8N (as shown) \$610.00
122.0651.369

QCUA1827L-8N (small bowl left)
122.0620.097



Outside Sink Rim Dimensions: 17 3/4" FB x 26 7/8" LR
Large Bowl Dimensions: 16" FB x 14" LR x 8" DP
Small Bowl Dimensions: 16" FB x 10" LR x 7" DP
Minimum Cabinet Size: 33"
Gauge: 20
Corner Radius: 50mm
Finish: Satin Finished Bowls with Silk Finished Rim
Drain Hole Location: Rear
Sound Dampening: Undercoating
Installation: Undermount
Shipping Weight: 13.8 lbs

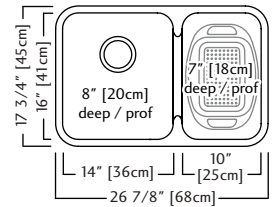

ACCESSORIES

- 1 Colander CA1W **Included**
- 2 Strainer Basket 1135
- 5 Bottom Grid BG13S
- 7 Bottom Grid BG10S
- 8 Drainer Basket DBR10S
- 9 Bamboo Bridge Cutting Board 112.0654.749

INCLUDED ACCESSORIES

- 1 Colander CA1W 112.0202.209 **On select models as indicated**

OPTIONAL ACCESSORIES

- 2 Strainer Basket 1135 \$25.00
- 3 Bottom Grid BGA1817S 112.0174.876 \$135.00
- 4 Bottom Grid BGA1217S 112.0174.874 \$95.00
- 5 Bottom Grid BG13S 112.0367.605 \$125.00
- 6 Bottom Grid BG11S 112.0044.786 \$120.00
- 7 Bottom Grid BG10S 112.044.785 \$120.00
- 8 Drainer Basket DBR10S 112.044.784 \$135.00
- 9 Bamboo Bridge Cutting Board 112.0654.749 \$150.00

QCU2031R-9N \$820.00
122.0046.344



Outside Sink Rim Dimensions: 20 5/8" FB x 31 1/2" LR
Large Bowl Dimensions: 18 1/2" FB x 17 3/4" LR x 9" DP
Small Bowl Dimensions: 16" FB x 10 5/8" LR x 7" DP
Minimum Cabinet Size: 36"
Gauge: 18
Corner Radius: 70mm
Finish: Silk Finished Bowls with Silk Finished Rim
Drain Hole Location: Rear
Sound Dampening: Sound Pads & Undercoating
Installation: Undermount
Shipping Weight: 26.0 lbs

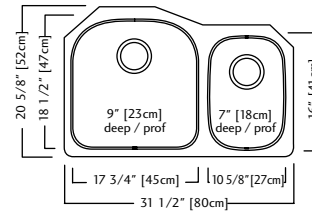

ACCESSORIES

- 1 Strainer Basket 1135
- 2 Bottom Grid BG30S
- 3 Bottom Grid BG35S
- 7 Bamboo Bridge Cutting Board 112.0654.749

QDUA1933-8N \$560.00
122.0620.083



Outside Sink Rim Dimensions: 18 3/4" FB x 32 7/8" LR
Equal Size Bowl Dimensions: 17" FB x 15" LR x 8" DP
Minimum Cabinet Size: 36"
Gauge: 20
Corner Radius: 50mm
Finish: Satin Finished Bowls with Silk Finished Rim
Drain Hole Location: Rear
Sound Dampening: Undercoating
Installation: Undermount
Shipping Weight: 16.1 lbs

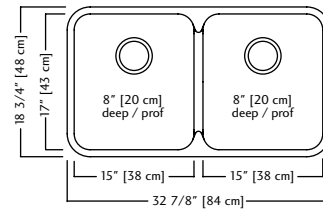

ACCESSORIES

- 1 Strainer Basket 1135
- 4 Bottom Grid BGA1517S
- 6 Drainer Basket DBR10S
- 7 Bamboo Bridge Cutting Board 112.0654.749

QDUA1831-8N \$575.00
122.0620.094



Outside Sink Rim Dimensions: 17 3/4" FB x 30 7/8" LR
Equal Size Bowl Dimensions: 16" FB x 14" LR x 8" DP
Minimum Cabinet Size: 36"
Gauge: 20
Corner Radius: 50mm
Finish: Satin Finished Bowls with Silk Finished Rim
Drain Hole Location: Rear
Sound Dampening: Undercoating
Installation: Undermount
Shipping Weight: 16.0 lbs

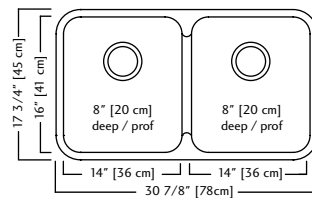

ACCESSORIES

- 1 Strainer Basket 1135
- 5 Bottom Grid BG10S
- 6 Drainer Basket DBR10S
- 7 Bamboo Bridge Cutting Board 112.0654.749



OPTIONAL ACCESSORIES



1 Strainer Basket
1135
112.0040.566
\$25.00



2 Bottom Grid
BG30S
112.0055.435
\$165.00



3 Bottom Grid
BG35S
112.0044.796
\$110.00



4 Bottom Grid
BGA1517S
112.0174.872
\$125.00



5 Bottom Grid
BG10S
112.0044.785
\$120.00



6 Drainer Basket
DBR10S
112.0044.784
\$135.00



7 Bamboo Bridge Cutting Board
112.0654.749
\$150.00



Pictured: QDLA2233-8-1N



Pictured: QSL2020-8-1N



STEEL QUEEN

Topmount / Drop In Sinks

A BEAUTIFUL HISTORY

Combining design and durability worthy of the Kindred Crown, Steel Queen sinks have been a homeowner's favorite for years.

Kindred's drop in sinks are widely regarded as some of the easiest-to-install. Simple enough for a DIY project, these versatile models are the top choice of many home renovators.

STYLE & VERSATILITY

Choose from a wide range of shapes, sizes and styles to suit any kitchen.



EZ TORQUE INSTALLATION

Simplified fastener system and drop-and-drill process make this one of the industry's quickest sinks to install.



REAR DRAIN

The placement of the drain has been designed to maximize bowl space.



QSLA2233-8-4N (4 faucet holes) \$665.00

101.0620.212

QSLA2233-8-3N (3 faucet holes)

101.0620.211

QSLA2233-8-1N (1 faucet hole)

101.0620.210



Outside Sink Rim Dimensions: 22" FB x 33 3/8" LR
Single Bowl Dimensions: 17" FB x 31" LR x 8" DP
Minimum Cabinet Size: 36"
Gauge: 20
Corner Radius: 50mm
Finish: Satin Finished Bowl with Mirror Finished Rim
Drain Hole Location: Rear
Sound Dampening: Undercoating
Installation: Topmount / Drop In
Shipping Weight: 16.4 lbs

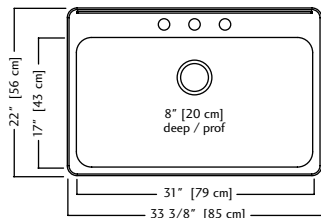

ACCESSORIES

- 1** Strainer Basket 1135 **2** Bottom Grid BGA3117S **7** Drainer Basket DBR10S



QSLA2217-8-3N (3 faucet holes) \$440.00

101.0620.215

QSLA2217-8-1N (1 faucet hole)

101.0620.216



Outside Sink Rim Dimensions: 22" FB x 17 1/4" LR
Single Bowl Dimensions: 17" FB x 15" LR x 8" DP
Minimum Cabinet Size: 21"
Gauge: 20
Corner Radius: 50mm
Finish: Satin Finished Bowl with Mirror Finished Rim
Drain Hole Location: Rear
Sound Dampening: Undercoating
Installation: Topmount / Drop In
Shipping Weight: 9.3 lbs

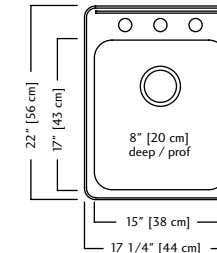

ACCESSORIES

- 1** Strainer Basket 1135 **5** Bottom Grid BGA1517S **7** Drainer Basket DBR10S



QSLA2031-8-4N (4 faucet holes) \$540.00

101.0620.244

QSLA2031-8-3N (3 faucet holes)

101.0620.243

QSLA2031-8-1N (1 faucet hole)

101.0620.242



Outside Sink Rim Dimensions: 20 1/2" FB x 31 1/4" LR
Single Bowl Dimensions: 16" FB x 29" LR x 8" DP
Minimum Cabinet Size: 33"
Gauge: 20
Corner Radius: 50mm
Finish: Satin Finished Bowl with Mirror Finished Rim
Drain Hole Location: Rear
Sound Dampening: Undercoating
Installation: Topmount / Drop In
Shipping Weight: 14.7 lbs

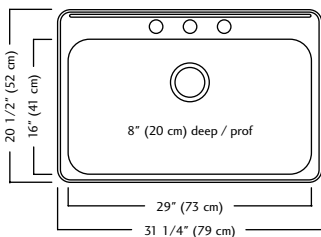

ACCESSORIES

- 1** Strainer Basket 1135 **3** Bottom Grid BG240S **7** Drainer Basket DBR10S



QSL2020-8-3N (3 faucet holes) \$295.00

101.0651.319

QSL2020-8-1N (1 faucet hole)

101.0651.317



Outside Sink Rim Dimensions: 20 1/2" FB x 20" LR
Single Bowl Dimensions: 16" FB x 18" LR x 8" DP
Minimum Cabinet Size: 24"
Gauge: 20
Corner Radius: 50mm
Finish: Satin Finished Bowl with Mirror Finished Rim
Drain Hole Location: Rear
Sound Dampening: Undercoating
Installation: Topmount / Drop In
Shipping Weight: 9.7 lbs

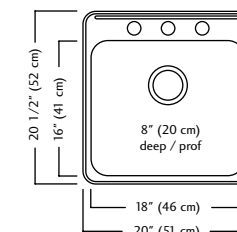

ACCESSORIES

- 1** Strainer Basket 1135 **6** Bottom Grid BG11S **7** Drainer Basket DBR10S



QSLA2225-8-4N (4 faucet holes) \$490.00

101.0652.568

QSLA2225-8-3N (3 faucet holes)

101.0620.214

QSLA2225-8-1N (1 faucet hole)

101.0620.213



Outside Sink Rim Dimensions: 22" FB x 25 1/4" LR
Single Bowl Dimensions: 17" FB x 23" LR x 8" DP
Minimum Cabinet Size: 27"
Gauge: 20
Corner Radius: 50mm
Finish: Satin Finished Bowl with Mirror Finished Rim
Drain Hole Location: Rear
Sound Dampening: Undercoating
Installation: Topmount / Drop In
Shipping Weight: 15.0 lbs

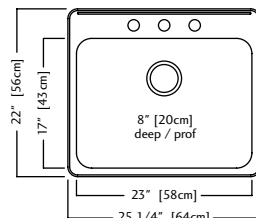

ACCESSORIES

- 1** Strainer Basket 1135 **4** Bottom Grid BGA2317S **7** Drainer Basket DBR10S



OPTIONAL
ACCESSORIES



- 1** Strainer Basket 1135 \$25.00
2 Bottom Grid BGA3117S 112.0040.566 \$190.00
3 Bottom Grid BG240S 112.0204.314 \$180.00
4 Bottom Grid BGA2317S 112.0174.875 \$165.00



- 5** Bottom Grid BGA1517S 112.0174.872 \$125.00
6 Bottom Grid BG11S 112.0044.786 \$120.00
7 Drainer Basket DBR10S 112.0044.784 \$135.00

QSA1820-8N \$295.00
101.0620.245



Outside Sink Rim Dimensions: 18 1/8" FB x 20 1/8" LR
Single Bowl Dimensions: 16" FB x 18" LR x 8" DP
Minimum Cabinet Size: 24"
Gauge: 20
Corner Radius: 50mm
Finish: Satin Finished Bowl with Mirror Finished Rim
Drain Hole Location: Rear
Sound Dampening: Undercoating
Installation: Topmount / Drop In
Shipping Weight: 9.9 lbs

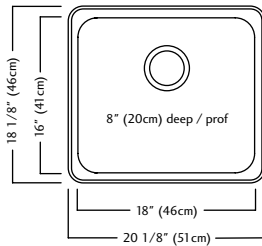

ACCESSORIES

- 2 Strainer Basket 1135 3 Bottom Grid BG11S 7 Drainer Basket DBR10S 8 Bamboo Bridge Cutting Board 112.0654.749



QSA1816-8N \$285.00
101.0620.246



Outside Sink Rim Dimensions: 18 1/8" FB x 16 1/8" LR
Single Bowl Dimensions: 16" FB x 14" LR x 8" DP
Minimum Cabinet Size: 18"
Gauge: 20
Corner Radius: 50mm
Finish: Satin Finished Bowl with Mirror Finished Rim
Drain Hole Location: Rear
Sound Dampening: Undercoating
Installation: Topmount / Drop In
Shipping Weight: 8.2 lbs

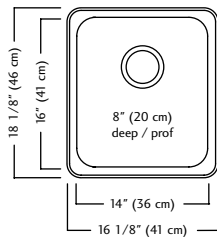

ACCESSORIES

- 2 Strainer Basket 1135 4 Bottom Grid BG10S 7 Drainer Basket DBR10S 8 Bamboo Bridge Cutting Board 112.0654.749



QSL2020-7-3N (3 faucet holes) \$230.00
101.0620.188
QSL2020-7-1N (1 faucet hole)
101.0620.187



Outside Sink Rim Dimensions: 20 1/2" FB x 20" LR
Single Bowl Dimensions: 16" FB x 18" LR x 7" DP
Minimum Cabinet Size: 24"
Gauge: 20
Corner Radius: 50mm
Finish: Satin Finished Bowl with Mirror Finished Rim
Drain Hole Location: Rear
Sound Dampening: Undercoating
Installation: Topmount / Drop In
Shipping Weight: 9.2 lbs

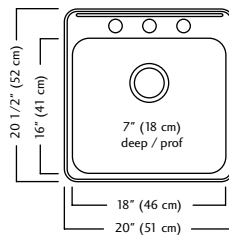

ACCESSORIES

- 2 Strainer Basket 1135 3 Bottom Grid BG11S 7 Drainer Basket DBR10S



QCLA2031R-8N (as shown)
QCLA2031R-8-3N (3 faucet holes)
101.0620.235

QCLA2031R-8-1N (1 faucet hole)
101.0620.234



QCLA2031L-8N (small bowl left) \$700.00
QCLA2031L-8-3N (3 faucet holes)
101.0620.237

QCLA2031L-8-1N (1 faucet hole)
101.0620.236

Outside Sink Rim Dimensions: 20 1/2" FB x 31 1/4" LR
Large Bowl Dimensions: 16" FB x 18" LR x 8" DP
Small Bowl Dimensions: 16" FB x 10" LR x 7" DP
Minimum Cabinet Size: 30"
Gauge: 20
Corner Radius: 50mm
Finish: Satin Finished Bowls with Mirror Finished Rim
Drain Hole Location: Rear
Sound Dampening: Undercoating
Installation: Topmount / Drop In
Shipping Weight: 15.9 lbs

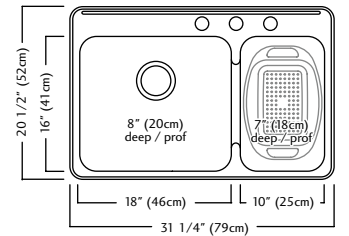

ACCESSORIES

- 1 Colander CA1W Included 2 Strainer Basket 1135 3 Bottom Grid BG11S 5 Bottom Grid BG13S 7 Drainer Basket DBR10S



QDLA2233-8-4N (4 faucet holes) \$675.00
101.0620.209

QDLA2233-8-3N (3 faucet holes)
101.0620.208

QDLA2233-8-1N (1 faucet hole)
101.0620.207



Outside Sink Rim Dimensions: 22" FB x 33 3/8" LR
Equal Size Bowl Dimensions: 17" FB x 15" LR x 8" DP
Minimum Cabinet Size: 36"
Gauge: 20
Corner Radius: 50mm
Finish: Satin Finished Bowls with Mirror Finished Rim
Drain Hole Location: Rear
Sound Dampening: Undercoating
Installation: Topmount / Drop In
Shipping Weight: 17.2 lbs

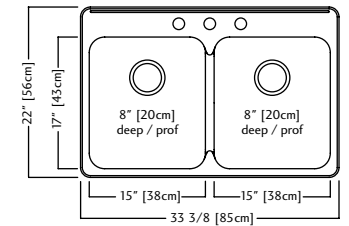

ACCESSORIES

- 2 Strainer Basket 1135 6 Bottom Grid BGA1517S 8 Bamboo Bridge Cutting Board 112.0654.749



INCLUDED ACCESSORIES



- 1 Colander CA1W
112.0202.209
On select models as indicated

OPTIONAL ACCESSORIES



- 2 Strainer Basket 1135
112.0040.566
\$25.00



- 3 Bottom Grid BG11S
112.0044.786
\$120.00



- 4 Bottom Grid BG10S
112.0044.785
\$120.00



- 5 Bottom Grid BG13S
112.0367.605
\$125.00



- 6 Bottom Grid BGA1517S
112.0174.872
\$125.00



- 7 Drainer Basket DBR10S
112.0044.784
\$135.00



- 8 Bamboo Bridge Cutting Board
112.0654.749
\$150.00

QCLA2027R-8N (as shown)
QCLA2027R-8-3N (3 faucet holes)
 101.0620.239

QCLA2027R-8-1N (1 faucet hole)
 101.0620.238



QCLA2027L-8N (small bowl left) \$665.00
QCLA2027L-8-3N (3 faucet holes)
 101.0620.241

QCLA2027L-8-1N (1 faucet hole)
 101.0620.240

Outside Sink Rim Dimensions: 20 9/16" FB x 27 1/4" LR
 Large Bowl Dimensions: 16" FB x 14" LR x 8" DP
 Small Bowl Dimensions: 16" FB x 10" LR x 7" DP
 Minimum Cabinet Size: 30"
 Gauge: 20
 Corner Radius: 50mm
 Finish: Satin Finished Bowls with Mirror Finished Rim
 Drain Hole Location: Rear
 Sound Dampening: Undercoating
 Installation: Topmount / Drop In
 Shipping Weight: 15.1 lbs

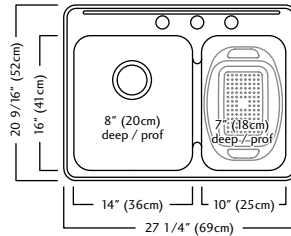

ACCESSORIES

- 1 Colander** CA1W **2 Strainer Basket** 1135 **3 Bottom Grid** BG10S **4 Bottom Grid** BG13S **7 Drainer Basket** DBR10S
 Included



QDC2031R-8-1N \$655.00
 101.0651.311



Outside Sink Rim Dimensions: 20 5/8" FB x 31 1/2" LR
 Large Bowl Dimensions: 18 1/2" FB x 17 3/4" LR x 8" DP
 Small Bowl Dimensions: 16" FB x 10 5/8" LR x 7" DP
 Minimum Cabinet Size: 33"
 Gauge: 20
 Corner Radius: 89mm
 Finish: Satin Finished Bowls with Mirror Finished Rim
 Drain Hole Location: Rear
 Sound Dampening: Undercoating
 Installation: Topmount / Drop In
 Shipping Weight: 22.4 lbs

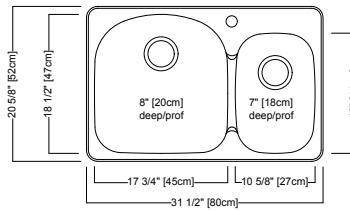

ACCESSORIES

- 2 Strainer Basket** 1135 **5 Bottom Grid** BG30S **6 Bottom Grid** BG35S



QDL2031-8-4N (4 faucet holes) \$500.00
 101.0620.186

QDL2031-8-3N (3 faucet holes)
 101.0620.185

QDL2031-8-1N (1 faucet hole)
 101.0620.184



Outside Sink Rim Dimensions: 20 1/2" FB x 31 1/4" LR
 Equal Size Bowl Dimensions: 16" FB x 14" LR x 8" DP
 Minimum Cabinet Size: 33"
 Gauge: 20
 Corner Radius: 50mm
 Finish: Satin Finished Bowls with Mirror Finished Rim
 Drain Hole Location: Rear
 Sound Dampening: Undercoating
 Installation: Topmount / Drop In
 Shipping Weight: 15.3 lbs

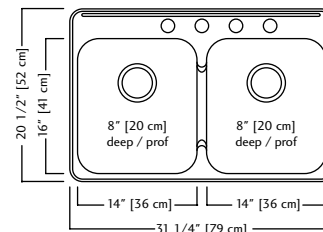

ACCESSORIES

- 2 Strainer Basket** 1135 **3 Bottom Grid** BG10S **7 Drainer Basket** DBR10S



QCM1826-7-3N (3 faucet holes) \$595.00
 101.0620.233

QCM1826-7-1N (1 faucet hole)
 101.0620.247



Outside Sink Rim Dimensions: 18 1/8" FB x 26 1/2" LR
 Large Bowl Dimensions: 16" FB x 14" LR x 7" DP
 Small Bowl Dimensions: 11 5/8" FB x 9 1/4" LR x 6" DP
 Minimum Cabinet Size: 30"
 Gauge: 20
 Corner Radius: 50mm
 Finish: Satin Finished Bowls with Mirror Finished Rim
 Drain Hole Location: Rear
 Sound Dampening: Undercoating
 Installation: Topmount / Drop In
 Shipping Weight: 12.8 lbs

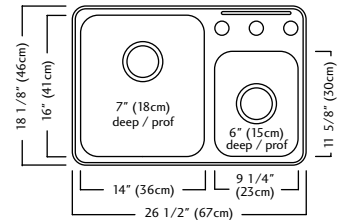

ACCESSORIES

- 2 Strainer Basket** 1135 **3 Bottom Grid** BG10S **7 Drainer Basket** DBR10S **8 Bamboo Bridge Cutting Board** 112.0654.749



QD1831-8N \$475.00
 101.0620.183



Outside Sink Rim Dimensions: 18 7/16" FB x 31 1/4" LR
 Equal Size Bowl Dimensions: 16" FB x 14" LR x 8" DP
 Minimum Cabinet Size: 33"
 Gauge: 20
 Corner Radius: 50mm
 Finish: Satin Finished Bowls with Mirror Finished Rim
 Drain Hole Location: Rear
 Sound Dampening: Undercoating
 Installation: Topmount / Drop In
 Shipping Weight: 17.2 lbs

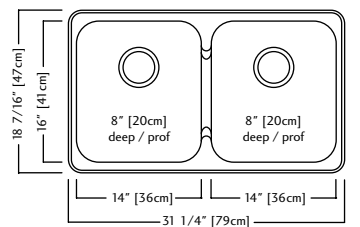

ACCESSORIES

- 2 Strainer Basket** 1135 **3 Bottom Grid** BG10S **7 Drainer Basket** DBR10S **8 Bamboo Bridge Cutting Board** 112.0654.749



INCLUDED ACCESSORIES

- 1 Colander** CA1W
 112.0202.209
 On select models as indicated

OPTIONAL ACCESSORIES

- 2 Strainer Basket** 1135 112.0040.785 \$25.00
3 Bottom Grid BG10S 112.0044.785 \$120.00
4 Bottom Grid BG13S 112.0367.605 \$125.00
5 Bottom Grid BG30S 112.0055.435 \$165.00
6 Bottom Grid BG35S 112.044.796 \$110.00
7 Drainer Basket DBR10S 112.0044.784 \$135.00
8 Bamboo Bridge Cutting Board 112.0654.749 \$150.00

QDL2031-7-4N (4 faucet holes) \$415.00

101.0651.313

QDL2031-7-3N (3 faucet holes)

101.0651.312

QDL2031-7-1N (1 faucet hole)

101.0181.724



Outside Sink Rim Dimensions: 20 1/2" FB x 31 1/4" LR
 Equal Size Bowl Dimensions: 16" FB x 14" LR x 7" DP
 Minimum Cabinet Size: 33"
 Gauge: 20
 Corner Radius: 50mm
 Finish: Satin Finished Bowls with Mirror Finished Rim
 Drain Hole Location: Rear
 Sound Dampening: Undercoating
 Installation: Topmount / Drop In
 Shipping Weight: 15.9 lbs

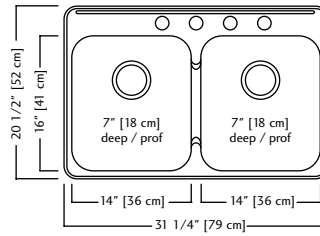

ACCESSORIES

- 1** Strainer Basket 1135
- 2** Bottom Grid BG10S
- 3** Drainer Basket DBR10S



OPTIONAL ACCESSORIES



- 1** Strainer Basket 1135
112.0040.566
\$25.00
- 2** Bottom Grid BG10S
112.0044.785
\$120.00
- 3** Drainer Basket DBR10S
112.0044.784
\$135.00





Pictured: QSL2020-10-1N



Pictured: QSLA2225-10-1N



STEEL QUEEN
Utility Sinks

BASIN BEAUTY

Rely on Kindred for high-performing beauty — in any room of the house.

Our designers have spent decades perfecting Kindred's stainless steel utility sinks, offered in a number of sizes and styles to suit any interior.

Tough yet refined, our finishes provide sanitary durability made to last.

- 

HIGHLY RESILIENT
Strong enough to take on life's messiest jobs with ease and is easy-to-clean and maintain.
- 

ULTRA QUIET
Sound dampening system that keeps your kitchen clear of excess noise from running water and disposal vibration.
- 

COMMERCIAL SATIN FINISH
Robust finished sinks stand up to heavy use while retaining their beauty for years.

QSLF2020-12-3 (3 faucet holes) \$1,035.00

101.0293.898

QSLF2020-12-1 (1 faucet hole)

101.0300.801



Outside Sink Rim Dimensions: 20 9/16" FB x 20 1/8" LR
Single Bowl Dimensions: 16" FB x 18" LR x 12" DP
Minimum Cabinet Size: 24"
Gauge: 18
Corner Radius: 25mm
Finish: Satin Finish
Drain Hole Location: Rear
Sound Dampening: Sound Pads & Undercoating
Installation: Dualmount
Shipping Weight: 32.3 lbs

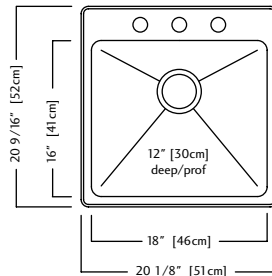

ACCESSORIES

- 1 Strainer Basket 1135 **Included**
- 4 Drainer Basket DBR10S

QSLF2020-10-3 (3 faucet holes) \$895.00

101.0293.893

QSLF2020-10-1 (1 faucet hole)

101.0300.792



Outside Sink Rim Dimensions: 20 9/16" FB x 20 1/8" LR
Single Bowl Dimensions: 16" FB x 18" LR x 10" DP
Minimum Cabinet Size: 24"
Gauge: 18
Corner Radius: 25mm
Finish: Satin Finish
Drain Hole Location: Rear
Sound Dampening: Sound Pads & Undercoating
Installation: Dualmount
Shipping Weight: 29.9 lbs

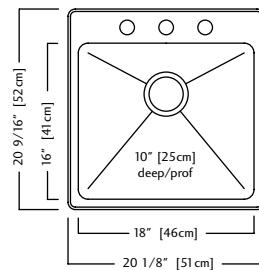

ACCESSORIES

- 1 Strainer Basket 1135 **Included**
- 4 Drainer Basket DBR10S

QSL2225-12-3N (3 faucet holes) \$835.00

101.0651.325

QSL2225-12-1N (1 faucet hole)

101.0651.324



Outside Sink Rim Dimensions: 22 1/16" FB x 25 5/8" LR
Single Bowl Dimensions: 17 1/2" FB x 23 1/2" LR x 12" DP
Minimum Cabinet Size: 27"
Gauge: 18
Corner Radius: 70mm
Finish: Satin Finished Bowl with Mirror Finished Rim
Drain Hole Location: Center
Sound Dampening: Undercoating
Installation: Topmount / Drop In
Shipping Weight: 20.4 lbs

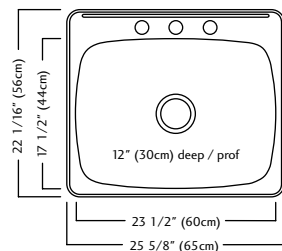

ACCESSORIES

- 1 Strainer Basket 1135



QSLA2225-10-4N (4 faucet holes) \$715.00

101.0689.153

QSLA2225-10-3N (3 faucet holes)

101.0620.259

QSLA2225-10-1N (1 faucet hole)

101.0620.258



Outside Sink Rim Dimensions: 22" FB x 25 1/4" LR
Single Bowl Dimensions: 17" FB x 23" LR x 10" DP
Minimum Cabinet Size: 27"
Gauge: 18
Corner Radius: 50mm
Finish: Satin Finished Bowl with Mirror Finished Rim
Drain Hole Location: Rear
Sound Dampening: Undercoating
Installation: Topmount / Drop In
Shipping Weight: 17.5 lbs

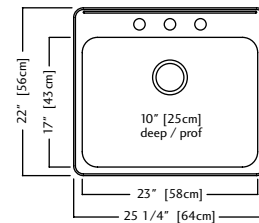

ACCESSORIES

- 1 Strainer Basket 1135
- 2 Bottom Grid BGA2317S



QSL2020-10-3N (3 faucet holes) \$525.00

101.0651.338

QSL2020-10-1N (1 faucet hole)

101.0651.336



Outside Sink Rim Dimensions: 20 9/16" FB x 20 1/8" LR
Single Bowl Dimensions: 16" FB x 18" LR x 10" DP
Minimum Cabinet Size: 24"
Gauge: 20
Corner Radius: 70mm
Finish: Satin Finished Bowl with Mirror Finished Rim
Drain Hole Location: Center
Sound Dampening: Undercoating
Installation: Topmount / Drop In
Shipping Weight: 14 lbs

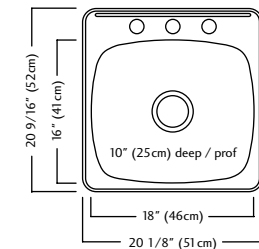

ACCESSORIES

- 1 Strainer Basket 1135
- 3 Bottom Grid BG110S



INCLUDED ACCESSORIES



- 1 Strainer Basket 1135
- 112.0040.566 \$25.00
- On select models as indicated**

OPTIONAL ACCESSORIES



- 2 Bottom Grid BGA2317S
- 112.0174.875 \$165.00



- 3 Bottom Grid BG110S
- 112.0040.526 \$165.00



- 4 Drainer Basket DBR10S
- 112.0044.784 \$135.00

QSU1820-10N \$520.00
122.0202.336



Outside Sink Rim Dimensions: 18 1/8" FB x 20 1/8" LR
Single Bowl Dimensions: 16" FB x 18" LR x 10" DP
Minimum Cabinet Size: 21"
Gauge: 20
Corner Radius: 70mm
Finish: Satin Finished Bowl with Satin Finished Rim
Drain Hole Location: Center
Sound Dampening: Undercoating
Installation: Undermount
Shipping Weight: 12.1 lbs

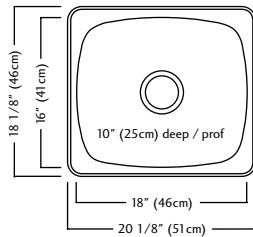

ACCESSORIES

- 1 Strainer Basket 1135 2 Bottom Grid BG110S

QS1820-10N \$510.00
101.0651.333



Outside Sink Rim Dimensions: 18 1/8" FB x 20 1/8" LR
Single Bowl Dimensions: 16" FB x 18" LR x 10" DP
Minimum Cabinet Size: 24"
Gauge: 20
Corner Radius: 70mm
Finish: Satin Finished Bowl with Mirror Finished Rim
Drain Hole Location: Center
Sound Dampening: Undercoating
Installation: Topmount / Drop In
Shipping Weight: 13.8 lbs

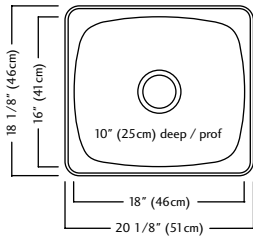

ACCESSORIES

- 1 Strainer Basket 1135 2 Bottom Grid BG110S



RSL2020-10-3N (3 faucet holes) \$415.00
101.0620.249
RSL2020-10-1N (1 faucet hole)
101.0651.330



Outside Sink Rim Dimensions: 20 9/16" FB x 20 1/8" LR
Single Bowl Dimensions: 16" FB x 18" LR x 10" DP
Minimum Cabinet Size: 24"
Gauge: 20
Corner Radius: 70mm
Finish: Linear Brushed Bowl and Mirror Finished Rim
Drain Hole Location: Center
Sound Dampening: Sound Pads
Installation: Topmount / Drop In
Shipping Weight: 14.0 lbs

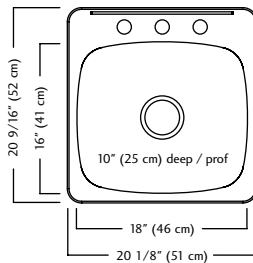

ACCESSORIES

- 1 Strainer Basket 1135 3 Bottom Grid BG110S



QCA1942-10N \$1,165.00



Outside Sink Rim Dimensions: 19 3/8" FB x 41 1/2" LR
Large Bowl Dimensions: 17" FB x 23" LR x 10" DP
Small Bowl Dimensions: 17" FB x 15" LR x 8" DP
Minimum Cabinet Size: 45"
Gauge: 18
Corner Radius: 50mm
Finish: Satin Finished Bowl with Mirror Finished Rim
Drain Hole Location: Rear
Sound Dampening: Undercoating
Installation: Topmount / Drop In
Shipping Weight: 25.5 lbs

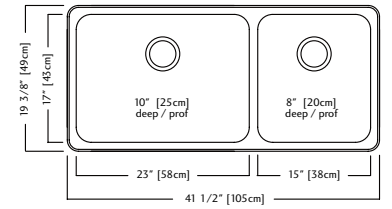

ACCESSORIES

- 1 Strainer Basket 1135 3 Bottom Grid BGA2317S 4 Bottom Grid BGA1517S



OPTIONAL
ACCESSORIES



- | | | | |
|--------------------------------------|---|---|---|
| 1 Strainer Basket
1135
\$25.00 | 2 Bottom Grid
BG110S
112.0040.566
\$165.00 | 3 Bottom Grid
BGA2317S
112.0174.875
\$165.00 | 4 Bottom Grid
BGA1517S
112.0174.872
\$125.00 |
|--------------------------------------|---|---|---|

QSR18-8N \$560.00
113.0620.198



Outside Sink Rim Dimension: 18 1/8" Diameter
Single Bowl Dimension: 16" Diameter x 8" DP
Minimum Cabinet Size: 21"
Gauge: 20
Finish: Satin Finished Bowl with Mirror Finished Rim
Drain Hole Location: Center
Sound Dampening: Undercoating
Installation: Topmount / Drop In
Shipping Weight: 8.5 lbs

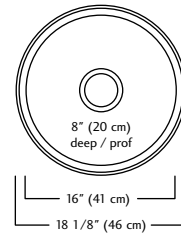

ACCESSORIES

- 1 Strainer Basket
1135



QSL1719-8-3N (3 faucet holes) \$390.00
101.0651.316

QSL1719-8-2N (2 faucet holes)
101.0651.315

QSL1719-8-1N (1 faucet hole)
101.0651.314



Outside Sink Rim Dimensions: 17" FB x 19 1/8" LR
Single Bowl Dimensions: 12" FB x 17" LR x 8" DP
Minimum Cabinet Size: 21"
Gauge: 20
Corner Radius: 70mm
Finish: Satin Finished Bowl with Mirror Finished Rim
Drain Hole Location: Center
Sound Dampening: Undercoating
Installation: Topmount / Drop In
Shipping Weight: 9 lbs

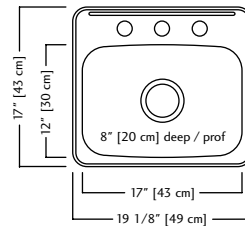

ACCESSORIES

- 1 Strainer Basket
1135



QSA1616-6N \$355.00
101.0629.536



Outside Sink Rim Dimensions: 16 1/8" FB x 16 1/8" LR
Single Bowl Dimensions: 14" FB x 14" LR x 6" DP
Minimum Cabinet Size: 18"
Gauge: 20
Corner Radius: 50mm
Finish: Satin Finished Bowl with Mirror Finished Rim
Drain Hole Location: Rear
Sound Dampening: Undercoating
Installation: Topmount / Drop In
Shipping Weight: 6.9 lbs

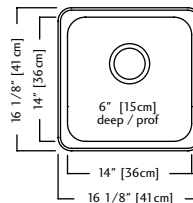

ACCESSORIES

- 1 Strainer Basket
1135
Included



QSL1515-6-2N (2 faucet holes) \$275.00
113.0620.197

QSL1515-6-1N (1 faucet hole)
113.0620.196



Outside Sink Rim Dimensions: 15 7/16" FB x 15 1/8" LR
Single Bowl Dimensions: 11" FB x 13" LR x 6" DP
Minimum Cabinet Size: 18"
Gauge: 20
Corner Radius: 50mm
Finish: Satin Finished Bowl with Mirror Finished Rim
Drain Hole Location: Center
Sound Dampening: Undercoating
Installation: Topmount / Drop In
Shipping Weight: 5.5 lbs

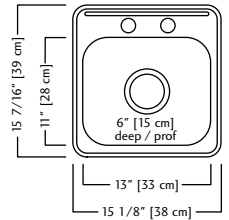

ACCESSORIES

- 1 Strainer Basket
1135



QS1315-6N \$255.00
113.0620.192



Outside Sink Rim Dimensions: 13 1/8" FB x 15 1/8" LR
Single Bowl Dimensions: 11" FB x 13" LR x 6" DP
Minimum Cabinet Size: 18"
Gauge: 20
Corner Radius: 50mm
Finish: Satin Finished Bowl with Mirror Finished Rim
Drain Hole Location: Center
Sound Dampening: Undercoating
Installation: Topmount / Drop In
Shipping Weight: 5.6 lbs

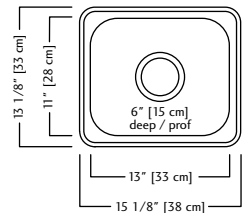

ACCESSORIES

- 1 Strainer Basket
1135



OPTIONAL
ACCESSORIES



- 1 Strainer Basket
1135
112.0040.566
\$25.00

* ADA Compliant: Product is compliant with the American Disabilities Act when properly installed

QSL1313-6-2N (2 faucet holes) \$225.00

113.0620.195

QSL1313-6-1N (1 faucet hole)

113.0620.194



Outside Sink Rim Dimensions: 13 5/8" FB x 13 5/8" LR
 Single Bowl Dimensions: 9 1/4" FB x 11 5/8" LR x 6" DP
 Minimum Cabinet Size: 18"
 Gauge: 20
 Corner Radius: 50mm
 Finish: Satin Finished Bowl with Mirror Finished Rim
 Drain Hole Location: Center
 Sound Dampening: Undercoating
 Installation: Topmount / Drop In
 Shipping Weight: 4.7 lbs

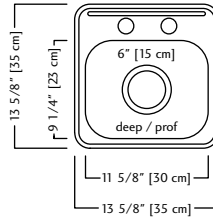

ACCESSORIES

- 1 Strainer Basket
1135



QS1113-6N \$225.00

113.0620.191



Outside Sink Rim Dimensions: 11 1/4" FB x 13 5/8" LR
 Single Bowl Dimensions: 9 1/4" FB x 11 5/8" LR x 6" DP
 Minimum Cabinet Size: 18"
 Gauge: 20
 Corner Radius: 50mm
 Finish: Satin Finished Bowl with Mirror Finished Rim
 Drain Hole Location: Center
 Sound Dampening: Undercoating
 Installation: Topmount / Drop In
 Shipping Weight: 5.0 lbs

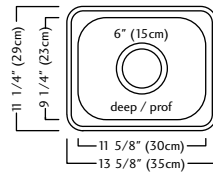

ACCESSORIES

- 1 Strainer Basket
1135



OPTIONAL
ACCESSORIES



- 1 Strainer Basket
1135
112.0040.566
\$25.00



Pictured: QSL1515-6-1N

* ADA Compliant: Product is compliant with the American Disabilities Act when properly installed



SINKS FOR REAL LIFE

Creemore Collection sinks were designed to make the daily grind less so.

With a complete range of features and styles that are easy to install and easy to maintain, they're sure to become easy to love- by builders, installers, and homeowners alike. On selected models, real life meets real simplicity with the EZ Torque installation process, cutting time off the job with smart engineering.

Pictured: CDLA3322-8-1CBN





Pictured: CCSLA2522-7-1N



Pictured: CSLA2522-8-1CBN



CREEMORE
Topmount / Drop In Sinks

QUIET AS A WHISPER

With pioneering Whisper Steel sound dampening pads, Creemore topmount sinks make even the busiest bowls a pleasure to use.

Installation is as easy as a few simple steps with our streamlined fastener system designed to lock the sink securely to the countertop. Worry-free steel from the industry leader in stainless ensures that Creemore topmount sinks will retain their style for years to come.



EZ TORQUE INSTALLATION
Simplified fastener system and drop-and-drill process make this one of the industry's quickest sinks to install.



ULTRA QUIET
Sound dampening system that keeps your kitchen clear of excess noise from running water and disposal vibration.



SPACIOUS BOWL CAPACITY
Greater capacity than traditional tapered bowls.

CSLA1515-6-2CBN \$210.00
101.0651.328



Outside Sink Rim Dimensions: 15" FB x 15" LR
Single Bowl Dimensions: 11" FB x 13" LR x 6" DP
Minimum Cabinet Size: 18"
Gauge: 20
Corner Radius: 50mm
Finish: Satin Finish
Drain Hole Location: 2" Center
Sound Dampening: Sound Pads
Installation: Topmount / Drop In
Shipping Weight: 5.5 lbs

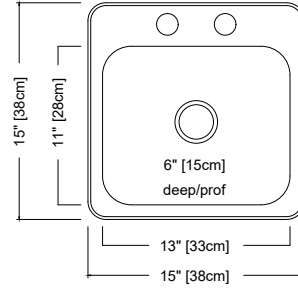

Strainer Not Included



CSLA2522-8-4CBN (4 faucet holes) \$200.00
101.0599.976

CSLA2522-8-3CBN (3 faucet holes)
101.0632.986

CSLA2522-8-1CBN (1 faucet hole)
101.0632.985



Outside Sink Rim Dimensions: 22" FB x 25" LR
Single Bowl Dimensions: 17" FB x 23" LR x 8" DP
Minimum Cabinet Size: 27"
Gauge: 20
Corner Radius: 50mm
Finish: Satin Finish
Drain Hole Location: Rear
Sound Dampening: Sound Pads
Installation: Topmount / Drop In
Shipping Weight: 9.6 lbs

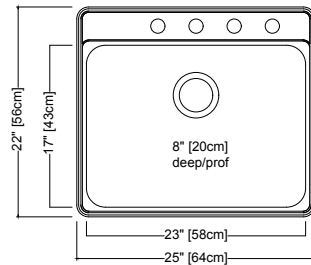

ACCESSORIES

- 1 Strainer Basket 2 Bottom Grid
4010856 BG2317R



CSLA2522-7-4N (4 faucet holes) \$180.00
101.0599.888

CSLA2522-7-3N (3 faucet holes)
101.0632.984

CSLA2522-7-1N (1 faucet hole)
101.0632.983



Outside Sink Rim Dimensions: 22" FB x 25" LR
Single Bowl Dimensions: 17" FB x 23" LR x 7" DP
Minimum Cabinet Size: 27"
Gauge: 22
Corner Radius: 50mm
Finish: Satin Finish
Drain Hole Location: Center
Sound Dampening: Sound Pads
Installation: Topmount / Drop In
Shipping Weight: 8.6 lbs

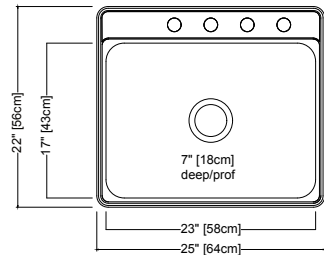

ACCESSORIES

- 1 Strainer Basket 3 Bottom Grid
4010856 BG2317C



CSLA2522-6-4N (4 faucet holes) \$170.00
101.0599.887

CSLA2522-6-3N (3 faucet holes)
101.0632.982

CSLA2522-6-1N (1 faucet hole)
101.0632.981



Outside Sink Rim Dimensions: 22" FB x 25" LR
Single Bowl Dimensions: 17" FB x 23" LR x 6" DP
Minimum Cabinet Size: 27"
Gauge: 22
Corner Radius: 50mm
Finish: Satin Finish
Drain Hole Location: Center
Sound Dampening: Sound Pads
Installation: Topmount / Drop In
Shipping Weight: 7.6 lbs

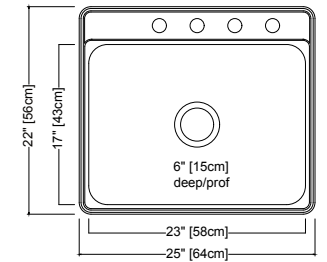

ACCESSORIES

- 1 Strainer Basket 3 Bottom Grid
4010856 BG2317C



FCDLA3322-8-4CBN (4 faucet holes) \$275.00
101.0652.632

FCDLA3322-8-3CBN (3 faucet holes)
101.0632.994

FCDLA3322-8-1CBN (1 faucet hole)
101.0632.993



Outside Sink Rim Dimensions: 22" FB x 33" LR
Equal Size Bowl Dimensions: 17" FB x 15" LR x 8" DP
Minimum Cabinet Size: 36"
Gauge: 18
Corner Radius: 50mm
Finish: Satin Finish
Drain Hole Location: Rear
Sound Dampening: Sound Pads
Installation: Topmount / Drop In
Shipping Weight: 17.2 lbs

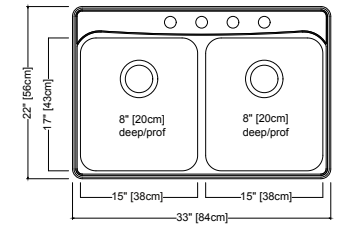

ACCESSORIES

- 1 Strainer Basket 4 Bottom Grid
4010856 BG1715R



OPTIONAL
ACCESSORIES



- | | | | |
|---|---|---|---|
| 1 Strainer Basket
4010856
\$25.00 | 2 Bottom Grid
BG2317R
112.0083.598
\$75.00 | 3 Bottom Grid
BG2317C
112.0611.545
\$75.00 | 4 Bottom Grid
BG1715R
112.0611.548
\$60.00 |
|---|---|---|---|

* ADA Compliant: Product is compliant with the American Disabilities Act when properly installed

CDLA3322-8-4CBN (4 faucet holes) \$255.00

101.0599.974

CDLA3322-8-3CBN (3 faucet holes)

101.0632.992

CDLA3322-8-1CBN (1 faucet hole)

101.0632.991



Outside Sink Rim Dimensions: 22" FB x 33" LR
Equal Size Bowl Dimensions: 17" FB x 15" LR x 8" DP
Minimum Cabinet Size: 36"
Gauge: 20
Corner Radius: 50mm
Finish: Satin Finish
Drain Hole Location: Rear
Sound Dampening: Sound Pads
Installation: Topmount / Drop In
Shipping Weight: 17.2 lbs

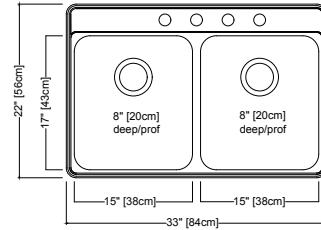

ACCESSORIES

- 1 Strainer Basket 4010856
- 2 Bottom Grid BG1715R



RDLA3319-6-4CBN \$200.00

101.0599.975



Outside Sink Rim Dimensions: 18 5/16" FB x 32 15/16" LR
Equal Bowl Dimensions: 14" FB x 14" LR x 6" DP
Minimum Cabinet Size: 36"
Gauge: 22
Corner Radius: 90mm
Finish: Satin Finish
Drain Hole Location: Rear
Sound Dampening: Sound Pads
Installation: Topmount / Drop In
Shipping Weight: 13.0 lbs

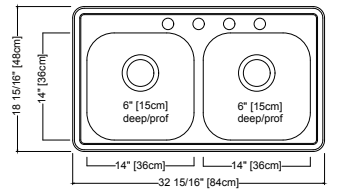

ACCESSORIES

- 1 Strainer Basket 4010856



Creemore
Topmount / Drop In

CDLA3322-7-4N (4 faucet holes) \$230.00

101.0599.973

CDLA3322-7-3N (3 faucet holes)

101.0632.990

CDLA3322-7-1N (1 faucet hole)

101.0632.989



Outside Sink Rim Dimensions: 22" FB x 33" LR
Equal Bowl Dimensions: 17" FB x 15" LR x 7" DP
Minimum Cabinet Size: 36"
Gauge: 22
Corner Radius: 50mm
Finish: Satin Finish
Drain Hole Location: Center
Sound Dampening: Sound Pads
Installation: Topmount / Drop In
Shipping Weight: 14.5 lbs

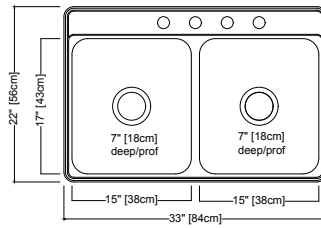

ACCESSORIES

- 1 Strainer Basket 4010856
- 3 Bottom Grid BG1715C



CDLA3322-6-4N (4 faucet holes) \$220.00

101.0599.972

CDLA3322-6-3N (3 faucet holes)

101.0632.988

CDLA3322-6-1N (1 faucet hole)

101.0632.987



Outside Sink Rim Dimensions: 22" FB x 33" LR
Equal Bowl Dimensions: 17" FB x 15" LR x 6" DP
Minimum Cabinet Size: 36"
Gauge: 22
Corner Radius: 50mm
Finish: Satin Finish
Drain Hole Location: Center
Sound Dampening: Sound Pads
Installation: Topmount / Drop In
Shipping Weight: 13.5 lbs

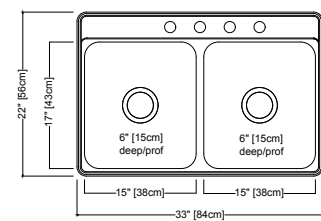

ACCESSORIES

- 1 Strainer Basket 4010856
- 3 Bottom Grid BG1715C



OPTIONAL ACCESSORIES



- 1 Strainer Basket 4010856
112.0083.598
\$25.00



- 2 Bottom Grid BG1715R
112.0611.548
\$60.00



- 3 Bottom Grid BG1715C
112.0611.546
\$60.00

* ADA Compliant: Product is compliant with the American Disabilities Act when properly installed

Creemore
Topmount / Drop In



Pictured: NS1930U-9N

PARAMOUNT SELECTION

The Reginox Collection brings exceptional value that will stand up to everyday chores.

Versatile in form and function, Kindred Reginox sinks offer exceptional value and selection — all backed with a Limited Lifetime manufacturer's warranty.



Pictured: NDC1827RU-9N



Pictured:RSU1820-7N



REGINOX
Undermount Sinks

A SINK FOR ANY SPACE

One size does not fit all- especially where sinks are concerned. Reginox sinks come in sizes and configurations to fit any room in the house.

Kindred's highly versatile undermount sinks are designed to sit under any solid surface counter. A seamless profile that introduces sleek style to your kitchen.

- 

UNDERMOUNT INSTALLATION
 Seamless profile brings sleek style to any kitchen.
- 

EASY TO CLEAN
 Gently sloping corners make cleaning a breeze and add a soft touch to any room.
- 

EASY CARE STAINLESS
 Sturdy 20-18 gauge steel from the industry leader in stainless, with a finish that will stand up to hard work, year in and year out.

NS1930U-9N \$345.00
122.0620.101



Outside Sink Rim Dimensions: 18 3/4" FB x 29 3/4" LR
Single Bowl Dimensions: 17" FB x 28" LR x 8 1/2" DP
Minimum Cabinet Size: 36"
Gauge: 18
Corner Radius: 70mm
Finish: Linear Brushed Bowl with Silk Finished Rim
Drain Hole Location: Rear
Sound Dampening: Undercoating
Installation: Undermount
Shipping Weight: 18.4 lbs

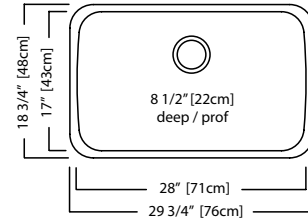

ACCESSORIES

- 1** Strainer Basket 1135 **2** Bottom Grid BG90S **5** Drainer Basket DBR10S

NS1925U-9N \$340.00
122.0620.100



Outside Sink Rim Dimensions: 18 3/4" FB x 24 3/4" LR
Single Bowl Dimensions: 17" FB x 23" LR x 8 1/2" DP
Minimum Cabinet Size: 30"
Gauge: 18
Corner Radius: 70mm
Finish: Linear Brushed Bowl with Silk Finished Rim
Drain Hole Location: Rear
Sound Dampening: Undercoating
Installation: Undermount
Shipping Weight: 15.3 lbs

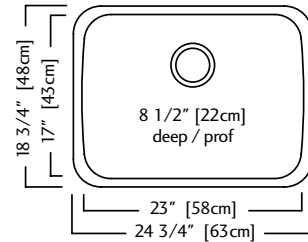

ACCESSORIES

- 1** Strainer Basket 1135 **3** Bottom Grid BG80S **5** Drainer Basket DBR10S

NS1820UA-9N \$265.00
122.0651.373



Outside Sink Rim Dimensions: 17 3/4" FB x 19 3/4" LR
Single Bowl Dimensions: 16" FB x 18" LR x 8 1/2" DP
Minimum Cabinet Size: 24"
Gauge: 18
Corner Radius: 70mm
Finish: Linear Brushed Bowl with Silk Finished Rim
Drain Hole Location: Rear
Sound Dampening: Undercoating
Installation: Undermount
Shipping Weight: 11.9 lbs

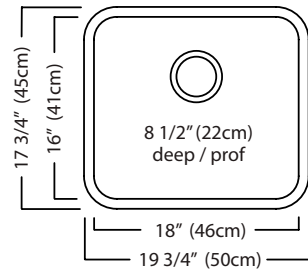

ACCESSORIES

- 1** Strainer Basket 1135 **4** Bottom Grid BG11S

RSU1820-7N \$230.00
122.0689.156



Outside Sink Rim Dimensions: 17 3/4" FB x 19 3/4" LR
Single Bowl Dimensions: 16" FB x 18" LR x 7" DP
Minimum Cabinet Size: 24"
Gauge: 20
Corner Radius: 70mm
Finish: Linear Brushed Bowl with Silk Finished Rim
Drain Hole Location: Rear
Sound Dampening: Sound Pads
Installation: Undermount
Shipping Weight: 7.9 lbs

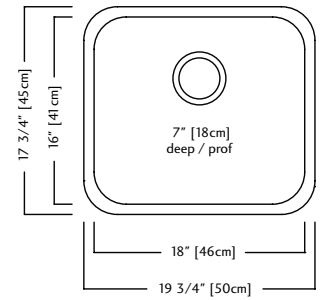

ACCESSORIES

- 1** Strainer Basket 1135 **4** Bottom Grid BG11S

NS1813U-7N \$200.00
122.0651.371



Outside Sink Rim Dimensions: 18 1/8" FB x 12 3/8" LR
Single Bowl Dimensions: 16" FB x 10 5/8" LR x 7" DP
Minimum Cabinet Size: 18"
Gauge: 18
Corner Radius: 89mm
Finish: Linear Brushed Bowl with Silk Finished Rim
Drain Hole Location: Rear
Sound Dampening: Undercoating
Installation: Undermount
Shipping Weight: 7.0 lbs

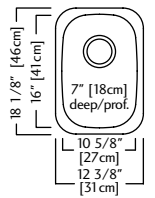

ACCESSORIES

- 1** Strainer Basket 1135 **6** Bottom Grid BG35S

OPTIONAL ACCESSORIES



- 1** Strainer Basket 1135 \$25.00
2 Bottom Grid BG90S 112.0040.566 \$165.00
3 Bottom Grid BG80S 112.0044.793 \$165.00



- 4** Bottom Grid BG11S 112.0044.786 \$120.00
5 Drainer Basket DBR10S 112.0044.784 \$135.00
6 Bottom Grid BG35S 112.0044.796 \$110.00

Reginox Undermount

Reginox Undermount

NDCX2132RU-9N \$485.00
122.0620.099



Outside Sink Rim Dimensions: 20 1/4" FB x 31 1/8" LR
Large Bowl Dimensions: 18 1/2" FB x 17 3/4" LR x 8 1/2" DP
Small Bowl Dimensions: 16" FB x 10 5/8" LR x 7" DP
Minimum Cabinet Size: 36"
Gauge: 18
Finish: Linear Brushed Bowl with Silk Finished Rim
Drain Hole Location: Rear
Sound Dampening: Undercoating
Installation: Undermount
Shipping Weight: 16.8 lbs

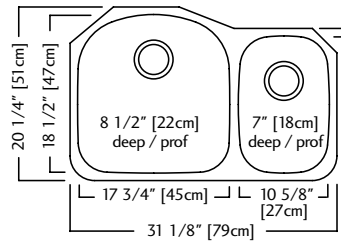

ACCESSORIES

- 1 Strainer Basket 1135
- 2 Bottom Grid BG35S
- 3 Bottom Grid BG30S

RDU1831-7N \$295.00
122.0689.155



Outside Sink Rim Dimensions: 17 3/4" FB x 30 7/8" LR
Equal size Bowl Dimensions: 16" FB x 14" LR x 7" DP
Minimum Cabinet Size: 36"
Gauge: 20
Corner Radius: 70mm
Finish: Linear Brushed Bowl with Silk Finished Rim
Drain Hole Location: Rear
Sound Dampening: Sound Pads
Installation: Undermount
Shipping Weight: 12.5 lbs

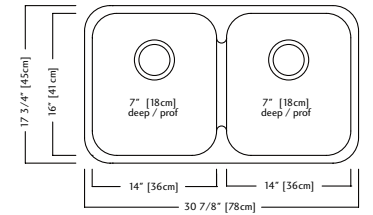

ACCESSORIES

- 1 Strainer Basket 1135
- 4 Bottom Grid BG10S
- 6 Drainer Basket DBR10S

ND1831UA-9N \$425.00
122.0620.108



Outside Sink Rim Dimensions: 17 3/4" FB x 30 7/8" LR
Equal Size Bowl Dimensions: 16" FB x 14" LR x 8 1/2" DP
Minimum Cabinet Size: 36"
Gauge: 18
Corner Radius: 50mm
Finish: Linear Brushed Bowl with Silk Finished Rim
Drain Hole Location: Rear
Sound Dampening: Undercoating
Installation: Undermount
Shipping Weight: 18.8 lbs

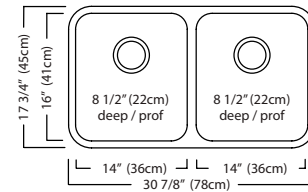

ACCESSORIES

- 1 Strainer Basket 1135
- 4 Bottom Grid BG10S
- 6 Drainer Basket DBR10S

NDC1827RU-9N \$435.00
122.0484.876



Outside Sink Rim Dimensions: 17 3/4" FB x 26 7/8" LR
Large Bowl Dimensions: 16" FB x 14" LR x 8 1/2" DP
Small Bowl Dimensions: 16" FB x 10" LR x 7" DP
Minimum Cabinet Size: 33"
Gauge: 18
Corner Radius: 70mm
Finish: Linear Brushed Bowl with Silk Finished Rim
Drain Hole Location: Rear
Sound Dampening: Undercoating
Installation: Undermount
Shipping Weight: 15.6 lbs

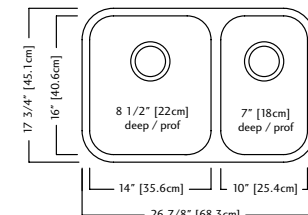



ACCESSORIES

- 1 Strainer Basket 1135
- 4 Bottom Grid BG10S
- 5 Bottom Grid BG13S
- 6 Drainer Basket DBR10S

OPTIONAL ACCESSORIES

-  1 Strainer Basket 1135
112.0040.566
\$25.00
-  2 Bottom Grid BG35S
112.0044.796
\$110.00
-  3 Bottom Grid BG30S
112.0055.435
\$165.00

-  4 Bottom Grid BG10S
112.0044.785
\$120.00
-  5 Bottom Grid BG13S
112.0367.605
\$125.00
-  6 Drainer Basket DBR10S
112.0044.784
\$135.00

Reginox Undermount

Reginox Undermount



Reginox
Topmount / Drop In

Pictured: RCL2027R-1N



Reginox
Topmount / Drop In

Pictured: RDL2031-1N



REGINOX

Topmount / Drop In Sinks

NO-HASSLE INSTALLATION

Upgrade your home easily with a highly versatile sink from the Reginox Collection.

These drop in sinks offer a variety of spacious bowl sizes, easy-to-clean lightly rounded corners, and configurations that combine style and practicality.

Easy to install, this topmount line includes large capacity models. Upgrade your cleaning power with a Reginox topmount.



TOPMOUNT / DROP IN INSTALLATION

A favorite for quick kitchen upgrades due to ease of installation and versatility of placement.



BRILLIANT FINISH

Pre-finished to a glowing, hygienic, and easy-to-clean finish.



EZ TORQUE INSTALLATION

Simplified fastener system and drop-and-drill process make this one of the industry's quickest sinks to install.

RSL2020-3N (3 faucet holes) \$210.00

101.0620.202

RSL2020-1N (1 faucet hole)

101.0620.201



Outside Sink Rim Dimensions: 20 9/16" FB x 20 1/8" LR
Single Bowl Dimensions: 16" FB x 18" LR x 7" DP
Minimum Cabinet Size: 24"
Gauge: 20
Corner Radius: 70mm
Finish: Linear Brushed Bowl and Mirror Finished Rim
Drain Hole Location: Center
Sound Dampening: Sound Pads
Installation: Topmount / Drop In
Shipping Weight: 9.0 lbs

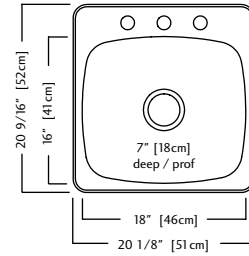

ACCESSORIES

- 1 Strainer Basket 1135
- 3 Bottom Grid BG110S



RDL2031-3N (3 faucet holes) \$345.00

101.0620.195

RDL2031-1N (1 faucet hole)

101.0620.194



Outside Sink Rim Dimensions: 20 1/2" FB x 31 1/4" LR
Equal size Bowl Dimensions: 16" FB x 14" LR x 7" DP
Minimum Cabinet Size: 33"
Gauge: 20
Corner Radius: 70mm
Finish: Linear Brushed Bowl and Mirror Finished Rim
Drain Hole Location: Rear
Sound Dampening: Sound Pads
Installation: Topmount / Drop In
Shipping Weight: 14.8 lbs

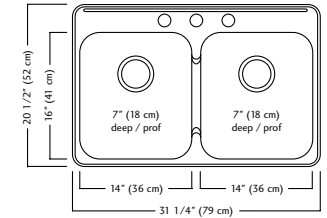

ACCESSORIES

- 1 Strainer Basket 1135
- 4 Bottom Grid BG10S
- 5 Drainer Basket DBR10S



RCL2027R-3N (3 faucet holes) \$390.00

101.0620.190

RCL2027R-1N (1 faucet hole)

101.0651.323



Outside Sink Rim Dimensions: 20 9/16" FB x 27 1/4" LR
Large Bowl Dimensions: 16" FB x 14" LR x 7" DP
Small Bowl Dimensions: 16" FB x 10" LR x 7" DP
Minimum Cabinet Size: 30"
Gauge: 20
Corner Radius: 70mm
Finish: Linear Brushed Bowl and Mirror Finished Rim
Drain Hole Location: Rear
Sound Dampening: Sound Pads
Installation: Topmount / Drop In
Shipping Weight: 13.9 lbs

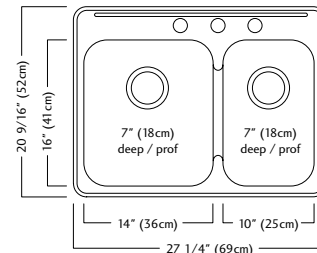

ACCESSORIES

- 1 Strainer Basket 1135
- 4 Bottom Grid BG10S
- 5 Drainer Basket DBR10S



OPTIONAL ACCESSORIES



- 1 Strainer Basket 1135 \$25.00
- 3 Bottom Grid BG110S 112.0040.566 \$165.00
- 4 Bottom Grid BG10S 112.0044.785 \$120.00
- 5 Drainer Basket DBR10S 112.0044.784 \$135.00

Reginox Topmount / Drop In

Reginox Topmount / Drop In



Reginox ADA

Pictured: RSU1925-55-1N



Reginox ADA

Pictured: RDLA3322-55-1N



REGINOX ADA Sinks

FUNCTIONAL DESIGN

Made to work with easy-to-clean corners, resilient finish, and sound dampening system, these sinks pair perfectly in traditional, contemporary, or transitional kitchen designs.

Offered in an assortment of configurations and installation options, Reginox ADA sinks deliver functional design for everyone without sacrificing quality or style.



ACCESSIBLE DESIGN

Shallow bowl depth and rear drain placement allows for sufficient knee space when sink is used in seated position.



BRILLIANT FINISH

Finished to a glowing, hygienic, and easy-to-clean satin finish.



EASY CARE STAINLESS

Sturdy 18 gauge steel from the industry leader in stainless, with a finish that will stand up to hard work, year in and year out.

RSU1829-55N \$415.00
122.0641.409



Outside Sink Rim Dimensions: 18 3/4" FB x 29 3/4" LR
Single Bowl Dimensions: 17" FB x 28" LR x 5 1/2" DP
Minimum Cabinet Size: 36"
Gauge: 18
Corner Radius: 70mm
Finish: Satin Finish
Drain Hole Location: Rear
Sound Dampening: Sound Pads
Installation: Undermount
Shipping Weight: 20 lbs
ADA Compliant

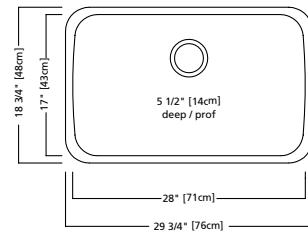

ACCESSORIES

- 1 Strainer Basket
1135



RSU1925-55N \$355.00
122.0641.410



Outside Sink Rim Dimensions: 18 3/4" FB x 24 3/4" LR
Single Bowl Dimensions: 17" FB x 23" LR x 5 1/2" DP
Minimum Cabinet Size: 30"
Gauge: 18
Corner Radius: 70mm
Finish: Satin Finish
Drain Hole Location: Rear
Sound Dampening: Sound Pads
Installation: Undermount
Shipping Weight: 15 lbs
ADA Compliant

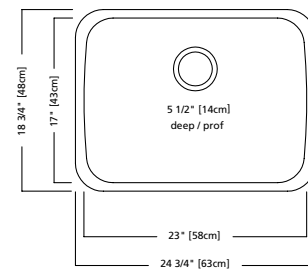

ACCESSORIES

- 1 Strainer Basket
1135



RSLA2522-55-4N (4 faucet holes) \$415.00
101.0643.205

RSLA2522-55-3N (3 faucet holes)
101.0643.204

RSLA2522-55-1N (1 faucet hole)
101.0643.203



Outside Sink Rim Dimensions: 22" FB x 25 5/8" LR
Single Bowl Dimensions: 17" FB x 23" LR x 5 1/2" DP
Minimum Cabinet Size: 27"
Gauge: 18
Corner Radius: 70mm
Finish: Satin Finish
Drain Hole Location: Rear
Sound Dampening: Sound Pads
Installation: Topmount / Drop In
Shipping Weight: 16 lbs
ADA Compliant

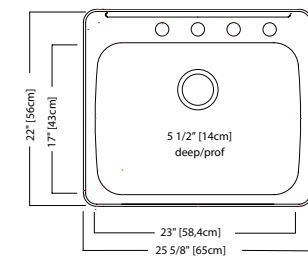

ACCESSORIES

- 2 Strainer Basket
1135



RDLA3322-55-4N (4 faucet holes) \$510.00
101.0643.202

RDLA3322-55-3N (3 faucet holes)
101.0643.201

RDLA3322-55-1N (1 faucet hole)
101.0643.200



Outside Sink Rim Dimensions: 22" FB x 33 1/4" LR
Equal Bowl Dimensions: 17" FB x 15" LR x 5 1/2" DP
Minimum Cabinet Size: 36"
Gauge: 18
Corner Radius: 70mm
Finish: Satin Finish
Drain Hole Location: Rear
Sound Dampening: Sound Pads
Installation: Topmount / Drop In
Shipping Weight: 20.7 lbs
ADA Compliant

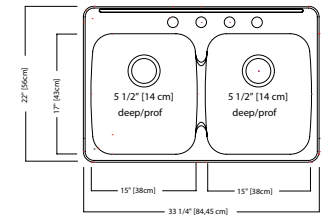

ACCESSORIES

- 1 Strainer Basket
1135



OPTIONAL
ACCESSORIES



- 1 Strainer Basket
1135
112.0040.566
\$25.00

* ADA Compliant: Product is compliant with the American Disabilities Act when properly installed &



Pictured: MGS2031U-95GN

WARM UP THE KITCHEN WITH GRANITE

A blend of ultra-modern design and durability, the Urban Granite Collection is perfect for today's home chef.

Made of granite, a blend of quartz and acrylic resin, these sinks are packed full of hidden design features that are made to maintain your granite sink's beauty for years to come. With the reliability guaranteed by the Kindred Crown, our granite sinks impart rich elegance in several sumptuous shades.



Urban Granite



Urban Granite Undermount

Pictured: MGC2034U-9SGV



Urban Granite Undermount

Pictured: MGS2031U-9PWTN



GRANITE
Undermount Sinks

NATURALLY UNDERSTATED

When a kitchen calls for a softer look than stainless, granite is the natural choice. Our Urban Granite pairs natural warmth and hard-working innovation.

Crafted for durability with Kindred's patented DuraKleen technology, our granite sinks resist stains and stand up to temperatures as high as 536°F / 280°C. Sanitized® technology makes sink surfaces resistant to microbial and bacterial growth. This means the finish repels most stains like wine, coffee, and grease.

COLORFAST PROTECTION

UV Protection ensures that these beauties maintain their natural tones for years.



SANITIZED® HYGIENE FUNCTION

Helps control bacterial odor and microbial growth.



SCRATCH RESISTANT

Made from high quality quartz and acrylic resin that makes the sink incredibly robust and hard wearing.



MGS2031U-9N \$630.00



MGS2031U-9CHAN Champagne	125.0637.113
MGS2031U-9MBKN Matte Black	125.0637.117
MGS2031U-9PWTN Polar White	125.0637.123
MGS2031U-9ONN Onyx	125.0627.115
MGS2031U-9ESN Mocha	125.0627.114
MGS2031U-9SGN Stone Grey	125.0627.116

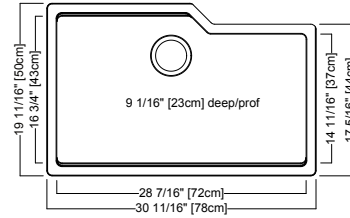

Outside Sink Rim Dimensions: 19 11/16" FB x 30 11/16" LR
 Single Bowl Dimensions: 16 3/4" FB x 28 7/16" LR X 9 1/16" DP
 Minimum Cabinet Size: 36"
 Corner Radius: 15mm
 Drain Hole Location: Rear
 Installation: Undermount
 Shipping Weight: 33.0 lbs

ACCESSORIES

- 1** Strainer Basket 1135
- 5** Bottom Grid BG410S
- 7** Cutting Board BB10
- 8** Colander C417P

MGS2022U-9N \$550.00



MGS2022U-9CHAN Champagne	125.0637.112
MGS2022U-9MBKN Matte Black	125.0637.116
MGS2022U-9PWTN Polar White	125.0637.120
MGS2022U-9ONN Onyx	125.0627.111
MGS2022U-9ESN Mocha	125.0627.110
MGS2022U-9SGN Stone Grey	125.0627.112

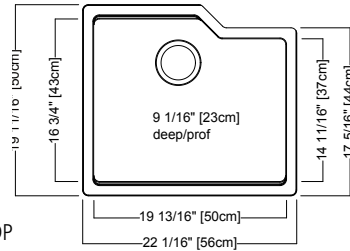

Outside Sink Rim Dimensions: 19 11/16" FB x 22 1/16" LR
 Single Bowl Dimensions: 16 3/4" FB x 19 13/16" LR X 9 1/16" DP
 Minimum Cabinet Size: 27"
 Corner Radius: 15mm
 Drain Hole Location: Rear
 Installation: Undermount
 Shipping Weight: 25.0 lbs

ACCESSORIES

- 1** Strainer Basket 1135
- 6** Bottom Grid BG400S
- 7** Cutting Board BB10
- 8** Colander C417P

MGC2034U-9N \$670.00



MGC2034U-9CHAN Champagne	125.0637.115
MGC2034U-9MBKN Matte Black	125.0637.119
MGC2034U-9PWTN Polar White	125.0637.122
MGC2034U-9ONN Onyx	125.0627.127
MGC2034U-9ESN Mocha	125.0627.122
MGC2034U-9SGN Stone Grey	125.0627.124

Outside Sink Rim Dimensions: 19 11/16" FB x 33 7/8" LR
 Large Bowl Dimensions: 16 3/4" FB x 16 15/16" LR x 9 1/16" DP
 Small Bowl Dimensions: 14 3/8" FB x 13 5/16" LR x 8 5/8" DP
 Minimum Cabinet Size: 39"
 Corner Radius: 15mm
 Drain Hole Location: Rear
 Installation: Undermount
 Shipping Weight: 40.0 lbs

ACCESSORIES

- 1** Strainer Basket 1135
- 2** Bottom Grid BG450S
- 3** Bottom Grid BG440S
- 7** Cutting Board BB10
- 8** Colander C417P

MGC2031U-9N \$650.00



MGC2031U-9CHAN Champagne	125.0637.114
MGC2031U-9MBKN Matte Black	125.0637.118
MGC2031U-9PWTN Polar White	125.0637.121
MGC2031U-9ONN Onyx	125.0627.119
MGC2031U-9ESN Mocha	125.0627.118
MGC2031U-9SGN Stone Grey	125.0627.120

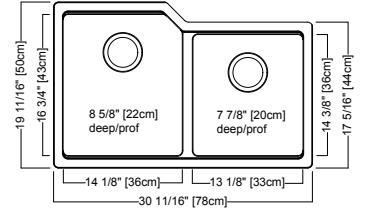

Outside Sink Rim Dimensions: 19 11/16" FB x 30 11/16" LR
 Large Bowl Dimensions: 16 3/4" FB x 14 1/8" LR x 8 5/8" DP
 Small Bowl Dimensions: 14 3/8" FB x 13 1/8" LR x 7 7/8" DP
 Minimum Cabinet Size: 36"
 Corner Radius: 15mm
 Drain Hole Location: Rear
 Installation: Undermount
 Shipping Weight: 35.0 lbs

ACCESSORIES

- 1** Strainer Basket 1135
- 4** Bottom Grid BG430S
- 3** Bottom Grid BG440S
- 7** Cutting Board BB10
- 8** Colander C417P

OPTIONAL ACCESSORIES

1 Strainer Basket 1135 112.0040.0566 \$25.00	2 Bottom Grid BG450S 112.0632.200 \$135.00	3 Bottom Grid BG440S 112.0632.198 \$120.00	4 Bottom Grid BG430S 112.0632.199 \$125.00
5 Bottom Grid BG410S 112.0632.196 \$190.00	6 Bottom Grid BG400S 112.0632.197 \$130.00	7 Cutting Board BB10 112.0644.464 \$165.00	8 Colander C417P 112.0538.950 \$75.00

CHA Champagne
 ES Mocha
 ON Onyx
 SG Stone Grey
 MBK Matte Black
 PWT Polar White
 Urban Granite Undermount

Urban Granite Undermount



Pictured: MGCM2034-9SGN



Pictured: MGSM2022-9ESN



URBAN GRANITE

Topmount / Drop In Sinks

EARTHY ELEGANCE

Natural textures and earth tones of Kindred Granite sinks will elevate your kitchen to match any contemporary or modern inspired style.

These sinks are crafted for maximum function. Their naturally sound-absorbing materials minimize noise and vibration, while a non-porous Sanitized® finish keeps germs away.

With reliability guaranteed by our Kindred Crown, these granite sinks impart a rich elegance in several sophisticated shades.



HEAT RESISTANT

Strong enough to withstand hot pans straight from the oven due to heat and thermal shock resistance.



DURAKLEEN

The smooth granite finish repels all stains like wine, coffee and grease. Cleans easily with soapy water.



SANITIZED® HYGIENE FUNCTION

Helps control bacterial odor and microbial growth.

MGSM2031-9N \$565.00

(3 pre-scored faucet holes)



MGSM2031-9CHAN Champagne	114.0637.945
MGSM2031-9MBKN Matte Black	114.0637.953
MGSM2031-9PWTN Polar White	114.0637.959
MGSM2031-9ONN Onyx	114.0643.415
MGSM2031-9ESN Mocha	114.0643.414
MGSM2031-9SGN Stone Grey	114.0643.416

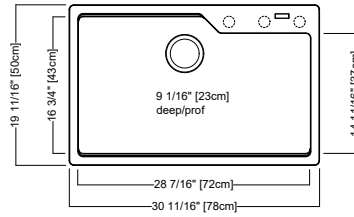

Outside Sink Rim Dimensions: 19 11/16" FB X 30 11/16" LR
 Single Bowl Dimensions: 16 3/4" FB x 28 7/16" LR x 9 1/16" DP
 Minimum Cabinet Size: 33"
 Corner Radius: 15mm
 Drain Hole Location: Rear
 Installation: Topmount / Drop In
 Shipping Weight: 36.5 lbs

ACCESSORIES

- 1** Strainer Basket 1135
- 5** Bottom Grid BG410S
- 7** Cutting Board BB10
- 8** Colander C417P

MGSM2022-9N \$490.00

(2 pre-scored faucet holes)



MGSM2022-9CHAN Champagne	114.0637.944
MGSM2022-9MBKN Matte Black	114.0637.952
MGSM2022-9PWTN Polar White	114.0637.982
MGSM2022-9ONN Onyx	114.0643.411
MGSM2022-9ESN Mocha	114.0643.410
MGSM2022-9SGN Stone Grey	114.0643.412

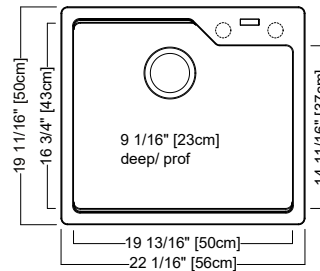

Outside Sink Rim Dimensions: 19 11/16" FB X 22 1/16" LR
 Single Bowl Dimensions: 16 3/4" FB x 19 13/16" LR x 9 1/16" DP
 Minimum Cabinet Size: 24"
 Corner Radius: 15mm
 Drain Hole Location: Rear
 Installation: Topmount / Drop In
 Shipping Weight: 27.0 lbs

ACCESSORIES

- 1** Strainer Basket 1135
- 6** Bottom Grid BG400S
- 7** Cutting Board BB10
- 8** Colander C417P

MGCM2034-9N \$610.00

(3 pre-scored faucet holes)



MGCM2034-9CHAN Champagne	114.0637.947
MGCM2034-9MBKN Matte Black	114.0637.955
MGCM2034-9PWTN Polar White	114.0637.957
MGCM2034-9ONN Onyx	114.0643.407
MGCM2034-9ESN Mocha	114.0643.406
MGCM2034-9SGN Stone Grey	114.0643.408

Outside Sink Rim Dimensions: 19 11/16" FB x 33 7/8" LR
 Large Bowl Dimensions: 16 3/4" FB x 16 15/16" LR x 9 1/16" DP
 Small Bowl Dimensions: 14 3/8" FB x 13 5/16" LR x 8 5/8" DP
 Minimum Cabinet Size: 36"
 Corner Radius: 15mm
 Drain Hole Location: Rear
 Installation: Topmount / Drop In
 Shipping Weight: 50.0 lbs

ACCESSORIES

- 1** Strainer Basket 1135
- 2** Bottom Grid BG450S
- 3** Bottom Grid BG440S
- 8** Colander C417P

MGCM2031-9N \$590.00

(3 pre-scored faucet holes)



MGCM2031-9CHAN Champagne	114.0637.946
MGCM2031-9MBKN Matte Black	114.0637.954
MGCM2031-9PWTN Polar White	114.0637.956
MGCM2031-9ONN Onyx	114.0643.403
MGCM2031-9ESN Mocha	114.0643.402
MGCM2031-9SGN Stone Grey	114.0643.404

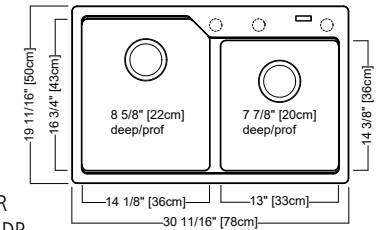

Outside Sink Rim Dimensions: 19 11/16" FB x 30 11/16" LR
 Large Bowl Dimensions: 16 3/4" FB x 14 1/8" LR x 8 5/8" DP
 Small Bowl Dimensions: 14 3/8" FB x 13" LR x 7 7/8" DP
 Minimum Cabinet Size: 33"
 Corner Radius: 15mm
 Drain Hole Location: Rear
 Installation: Topmount / Drop In
 Shipping Weight: 49.0 lbs

ACCESSORIES

- 1** Strainer Basket 1135
- 4** Bottom Grid BG430S
- 3** Bottom Grid BG440S
- 7** Cutting Board BB10
- 8** Colander C417P

OPTIONAL ACCESSORIES



1 Strainer Basket
1135
112.0040.0566
\$25.00



2 Bottom Grid
BG450S
112.0632.200
\$135.00



3 Bottom Grid
BG440S
112.0632.198
\$120.00



4 Bottom Grid
BG430S
112.0632.199
\$125.00



5 Bottom Grid
BG410S
112.0632.196
\$190.00



6 Bottom Grid
BG400S
112.0632.197
\$130.00



7 Cutting Board
BB10
112.0644.464
\$165.00



8 Colander
C417P
112.0538.950
\$75.00



CLEAN MACHINE

Kindred's waste disposers ensure durability and reliability at every step of clean-up.

Crafted with the Crown's standard of excellence, our waste disposers feature a sound-insulated shell for quiet performance. EZ Mount installation makes our disposers easy to install with just a few tools. Outfit your kitchen with Kindred's quality engineering and strength — right down to the drain.



Waste Disposers

KWD33C1-EZ \$205.00

134.0255.892



Horsepower: 1/3
 High-speed 1925 r.p.m. permanent magnet motor
 EZ mount installation system
 Stainless steel grinding components
 Includes factory installed power cord
 Safe for properly sized septic tanks
 For use with 110-120 volts/60hz current only
 Includes strainer stopper
 2 year warranty
 Antimicrobial treatment to inhibit odour
 Balanced grinding system to provide long service life & quiet operation
 Continuous feed
 Shipping Weight: 8.7 lbs

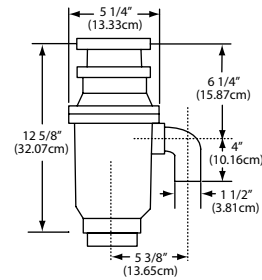

KWD75B1-EZ \$580.00

134.0275.324



Horsepower: 3/4
 High-speed 2700 r.p.m. permanent magnet motor
 EZ mount installation system
 Stainless steel grinding components
 Sound insulated shell
 Includes factory installed power cord
 Safe for properly sized septic tanks
 For use with 110-120 volts/60hz current only
 Includes strainer stopper
 8 year warranty
 Antimicrobial treatment to inhibit odour
 Balanced grinding system to provide long service life & quiet operation
 Batch feed
 Shipping Weight: 14 lbs

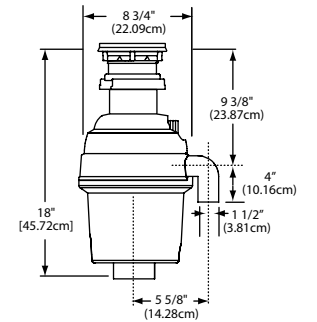

KWD50C1-EZ \$285.00

134.0255.890



Horsepower: 1/2
 High-speed 2600 r.p.m. permanent magnet motor
 EZ mount installation system
 Stainless steel grinding components
 Sound insulated shell
 Includes factory installed power cord
 Safe for properly sized septic tanks
 For use with 110-120 volts/60hz current only
 Includes strainer stopper
 5 year warranty
 Antimicrobial treatment to inhibit odour
 Balanced grinding system to provide long service life & quiet operation
 Continuous feed
 Shipping Weight: 10.6 lbs

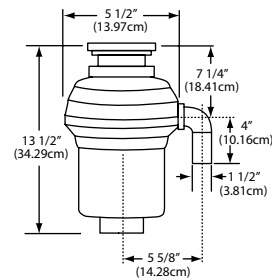

KWD125C1-EZ \$580.00

134.0255.899



Horsepower: 1 1/4
 High-speed 2800 r.p.m. permanent magnet motor
 EZ mount installation system
 Stainless steel grinding components
 Sound insulated shell
 Includes factory installed power cord
 Safe for properly sized septic tanks
 For use with 110-120 volts/60hz current only
 Includes strainer stopper
 10 year warranty
 Antimicrobial treatment to inhibit odour
 Balanced grinding system to provide long service life & quiet operation
 Continuous feed
 Shipping Weight: 15 lbs

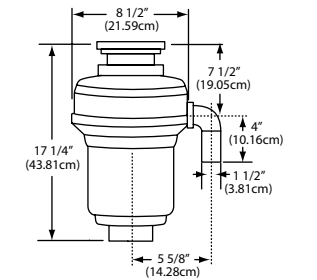

KWD50C2-EZ \$235.00

134.0262.596



Horsepower: 1/2
 High-speed 2600 r.p.m. permanent magnet motor
 EZ mount installation system
 Stainless steel grinding components
 Sound insulated shell
 Includes factory installed power cord
 Safe for properly sized septic tanks
 For use with 110-120 volts/60hz current only
 Includes strainer stopper
 2 year warranty
 Antimicrobial treatment to inhibit odour
 Balanced grinding system to provide long service life & quiet operation
 Continuous feed
 Shipping Weight: 10.6 lbs

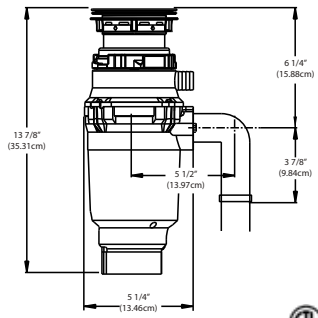

KWD125B1-EZ \$620.00

134.0315.656



Horsepower: 1 1/4
 High-speed 2800 r.p.m. permanent magnet motor
 EZ mount installation system
 Stainless steel grinding components
 Sound insulated shell
 Includes factory installed power cord
 Safe for properly sized septic tanks
 For use with 110-120 volts/60hz current only
 Includes strainer stopper
 10 year warranty
 Antimicrobial treatment to inhibit odour
 Balanced grinding system to provide long service life & quiet operation
 Batch feed
 Shipping Weight: 15 lbs

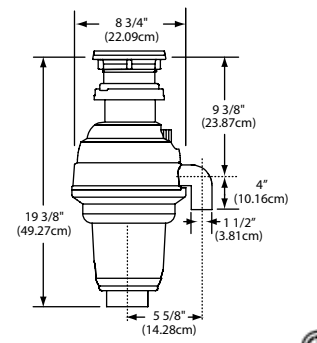

KWD75C1-EZ \$335.00

134.0255.898



Horsepower: 3/4
 High-speed 2700 r.p.m. permanent magnet motor
 EZ mount installation system
 Stainless steel grinding components
 Sound insulated shell
 Includes factory installed power cord
 Safe for properly sized septic tanks
 For use with 110-120 volts/60hz current only
 Includes strainer stopper
 8 year warranty
 Antimicrobial treatment to inhibit odour
 Balanced grinding system to provide long service life & quiet operation
 Continuous feed
 Shipping Weight: 12.0 lbs

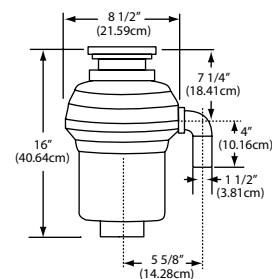

ACCESSORIES

AS200 \$220.00

112.0312.211



Includes separate chrome and satin nickel finished air switch control buttons
 For use with continuous feed waste disposers
 Can be used with waste disposers up to 1 H.P., 120 V
 Eliminates need for an electrical wall switch
 Installs into existing sink hole drilling, or countertop
 Air actuated on/off control
 Shipping Weight: 1.5 lbs

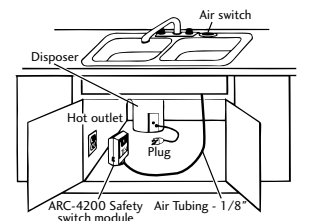



Sink Accessories

DELIGHTFUL DETAILS

No sink is complete without beautifully-designed and brilliantly-functional accessories.

Kindred offers an array of carefully crafted items sure to work seamlessly with our sinks and inspire creativity in kitchen. Simplify meal prep and clean-up with accessories bearing the Kindred Crown — from colanders and drainers to cutting boards and grids. Whether you're chopping vegetables or washing dishes, the right accessories make the job a breeze.

Make your Kindred sink the high-functioning hub you require with accessories built to match beautifully — and to last.

NEW

112.0654.749 \$150.00



Bamboo Bridge Cutting Board
20 15/16" FB x 11" LR x 1 1/4" HIGH

MB517 \$160.00



Laminated Bamboo Cutting Board
17 1/2" FB x 11" LR x 1" HIGH

BB10 \$165.00



Laminated Bamboo Cutting Board
17 1/4" FB x 10 3/4" LR x 1" HIGH

C417P \$75.00



Grey ABS Colander
17.25" FB x 7" LR x 3 1/2" DEEP

CA1W \$55.00



White ABS Colander
13" FB x 9" LR x 4 1/2" DEEP

DBR10S \$135.00



Polished Stainless Steel
Drainer Basket
14 5/8" FB x 12" LR x 3" HIGH

RM55S \$175.00



Polished Flexible
Stainless Steel Roller Mat
18" FB x 14 3/8" LR x 3/8" HIGH

BG10S \$120.00



Polished Stainless Steel
Bottom Grid
14 1/4" FB x 11 7/8" LR x 1" HIGH

BG11S \$120.00



Polished Stainless Steel
Bottom Grid
14 1/4" FB x 15 1/4" LR x 1" HIGH

BG13S \$125.00

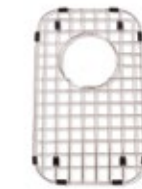

Polished Stainless Steel
Bottom Grid
14 1/4" FB x 8 1/4" LR x 1" HIGH

BG14S \$125.00

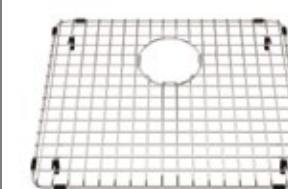

Polished Stainless Steel
Bottom Grid
15" FB x 18" LR x 1" HIGH

BG30S \$165.00



Polished Stainless Steel
Bottom Grid
16 7/8" FB x 16 3/16" LR x 1" HIGH

BG35S \$110.00



Polished Stainless Steel
Bottom Grid
14 1/4" FB x 8 1/2" LR x 1" HIGH

BG80S \$165.00

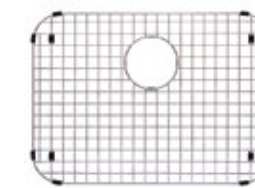

Polished Stainless Steel
Bottom Grid
14 3/4" FB x 20 3/8" LR x 1" HIGH

BG90S \$165.00



Polished Stainless Steel
Bottom Grid
14 5/8" FB x 25 1/4" LR x 1" HIGH

BG110S \$165.00

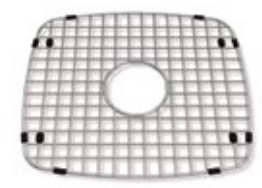

Polished Stainless Steel
Bottom Grid
13 7/8" FB x 15 7/8" LR x 1" HIGH

BG240S \$180.00

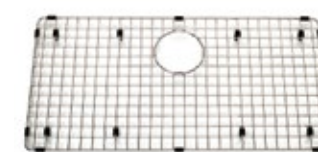

Polished Stainless Steel
Bottom Grid
14 1/4" FB x 27 1/4" LR x 1" HIGH

BG400S \$130.00



Polished Stainless Steel
Bottom Grid
15" FB x 18 1/4" LR x 1" HIGH

BG410S \$190.00

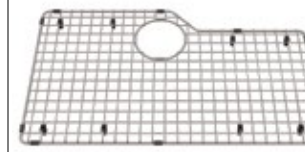

Polished Stainless Steel
Bottom Grid
15" FB x 26 1/2" LR x 1" HIGH

BG430S \$125.00

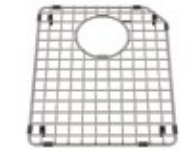

Polished Stainless Steel
Bottom Grid
15" FB x 12 1/4" LR x 1" HIGH

BG440S \$120.00

Polished Stainless Steel
Bottom Grid
13" FB x 11 3/4" LR x 1" HIGH

BG450S \$135.00

Polished Stainless Steel
Bottom Grid
15" FB x 15 1/4" LR x 1" HIGH

BG510S \$135.00

Polished Stainless Steel
Bottom Grid
15" FB x 8 3/4" LR x 1" HIGH

BG514S \$140.00

Polished Stainless Steel
Bottom Grid
15" FB x 12 1/2" LR x 1" HIGH

BG515S \$150.00

Polished Stainless Steel
Bottom Grid
15" FB x 13 1/2" LR x 1" HIGH

BG518S \$165.00

Polished Stainless Steel
Bottom Grid
15" FB x 16 1/2" LR x 1" HIGH

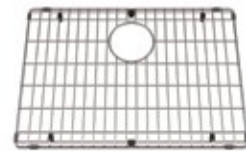
BG523S \$170.00

Polished Stainless Steel
Bottom Grid
15" FB x 21 1/2" LR x 1" HIGH

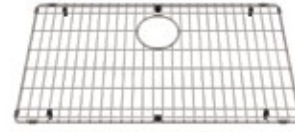
BG529S \$180.00

Polished Stainless Steel
Bottom Grid
15" FB x 27 1/2" LR x 1" HIGH

BG531S \$190.00

Polished Stainless Steel
Bottom Grid
15" FB x 29 1/2" LR x 1" HIGH

BG5310S \$190.00

Polished Stainless Steel
Bottom Grid
15" FB x 29 1/2" LR x 1" HIGH

BG1715C \$60.00

Polished Stainless Steel
Bottom Grid
15 1/2" FB x 13 1/2" LR x 1" HIGH

BG1715R \$60.00

Polished Stainless Steel
Bottom Grid
15 1/2" FB x 13 1/2" LR x 1" HIGH

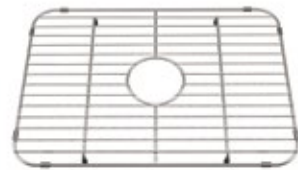
BG2317C \$75.00

Polished Stainless Steel
Bottom Grid
15 1/2" FB x 21 1/2" LR x 1" HIGH

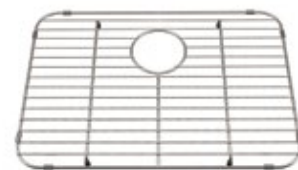
BG2317R \$75.00

Polished Stainless Steel
Bottom Grid
15 1/2" FB x 21 1/2" LR x 1" HIGH

BGA1217S \$95.00

Polished Stainless Steel
Bottom Grid
15" FB x 10 1/8" LR x 1" HIGH

BGA1517S \$125.00

Polished Stainless Steel
Bottom Grid
15" FB x 13" LR x 1" HIGH

BGA1817S \$135.00

Polished Stainless Steel
Bottom Grid
15" FB x 16" LR x 1" HIGH

BGA2317S \$165.00

Polished Stainless Steel
Bottom Grid
15" FB x 21" LR x 1" HIGH

BGA3117S \$190.00

Polished Stainless Steel
Bottom Grid
15" FB x 29" LR x 1" HIGH

61621 \$15.00

Stainless Steel Cleaner

61411 \$20.00

Sink Maintenance Kit

4010856 \$15.00

Stainless Strainer Assembly

1135 \$25.00

Stainless Strainer Assembly

1135-CS \$25.00

Stainless Strainer Assembly
in Clam Shell Packaging

1140 \$40.00

Stainless Strainer Assembly

1135T \$7.00

Polypropylene Tailpiece
with Rubber Gasket

1130B \$15.00

Stainless Strainer Basket

1135B-CS \$11.00

Stainless Strainer Basket
in Clam Shell Packaging

100 \$20.00

1 1/2" Stainless Steel Waste
Fitting with Brass Tailpiece
& Rubber Stopper

1047 \$30.00

Integral Waste Assembly

31703 \$15.00

EZ Torque Sink Fastener

EL-CLIPS \$7.00

Undermount Installation Bracket

31548 \$5.00

8 Pc. Bolt & Claw Assembly
in Poly Bag

20102 \$7.00

Undermount Installation
Hardware Kit
Kindred undermount hardware kit
requires 3" additional cabinet space

Franke Home Solutions Warranty for Kindred Branded Product

Effective September 1, 2022

In the United States, Canada and Latin America, Franke warrants the Kindred products from manufacturing defects in material and workmanship when purchased from Franke or a Franke/Kindred Authorized Retailer pursuant to product-specific warranties detailed herein (each, a "Warranty" and collectively, the "Warranties"). The products must be properly installed, per company's installations instructions, in its original installation, and used in normal indoor residential kitchen applications. Any products or components which have been modified or altered, from its original intended condition will void the warranty. The Franke Warranties for Kindred branded products are limited to the original purchaser and are non-transferrable. These Warranties do not include products purchased from non-Authorized Retailers, products that are obsolete or discontinued, or products that were previous display models. All issues with installed products are considered warranty claims and not subject to the Return Policy. Franke reserves the right to inspect any Kindred product reported to be defective and the original installation prior to providing a replacement product and/or component. All decisions are final. In no situation shall the liability of Franke exceed the amount of the original purchase price.

The Warranties do not cover, and Franke shall not be liable for, any damage to products or components resulting from misuse or abuse, accidental damages, normal wear such as scuffs, scratches or finish reduction/fading; improper installation, abnormal usage, negligence, damage caused by improper maintenance or cleaning. Damage caused by impurities, corrosive chemicals or acts beyond Franke's control are not covered by any Warranty.

Kindred product replacements do not include transportation, shipping, diagnosis, labor, installation, removal, disposal for any products or liability for project delays. Product replacements are not guaranteed to be exact replacements. The owner of a product is liable for any transportation and re-installation costs related to any warranty for such product. If the original product is not available at the time of the warranty claim, at Franke's option, the product replacements will be of similar size, material, and value. Any products or components which have been modified or altered, from its original intended condition will void the warranty.

The Warranties do not allow recovery of incidental or consequential damages such as loss of use, delay, property damage or other consequential damage, and Franke accepts no liability for such damages. Each Warranty is limited to the conditions set forth herein and to the applicable warranty period specified herein and is exclusive. EXCEPT FOR THE WARRANTIES SET FORTH HEREIN, FRANKE MAKES NO WARRANTY WHATSOEVER WITH RESPECT TO THE PRODUCTS, INCLUDING, BUT NOT LIMITED TO, (1) ANY WARRANTY OF MERCHANTABILITY, (2) WARRANTY OF FITNESS FOR A PARTICULAR PURPOSE, (3) WARRANTY OF TITLE, OR (4) WARRANTY AGAINST INFRINGEMENT OF INTELLECTUAL PROPERTY RIGHTS OF A THIRD PARTY, WHETHER EXPRESS OR IMPLIED BY LAW, COURSE OF DEALING, COURSE OF PERFORMANCE, USAGE OF TRADE OR OTHERWISE. LEGAL DISCLAIMER PLEASE READ CAREFULLY. Franke Home Solutions North America, LLC/Franke Kindred Canada Limited provides the above information to you as a public service to our customers. By accessing and using this information, you agree to the following and to comply with all applicable laws. If you do not agree with these terms and conditions, do not use this information. While we try to keep the information current, changes may have occurred since its creation. Contact your Regional Manager or Customer Service to verify information regarding Franke Home Solutions North America, LLC/Franke Kindred Canada programs and their use by you.

Kindred Residential Stainless and Granite Sink Limited Lifetime Warranty:

Franke warrants that each Kindred sink will be free from manufacturing defects in material and workmanship for the lifetime of the sink when used in standard residential indoor applications. The warranty covers sinks installed in its original installation per Franke/Kindred installation instructions in residential applications using conventional or solid surface countertop.

Kindred Residential Disposal Limited Warranty:

Franke warrants that Kindred disposers are free from manufacturing defects in material and workmanship for the period ranging from two (2) years to ten (10) years as documented in the annual product catalogs and/or instructions included with the products.

Kindred Residential Faucet Limited Warranty:

Franke warrants that mechanical components (body, handle and spout) in all Kindred faucets purchased after January 1, 2022, will be free of manufacturing defects for ten (10) years. Franke shall not be liable for any damage caused by normal wear and tear to wearable parts of the faucet. The expected useful lifetime of wearable parts is; one (1) year: aerator, o-rings; five (5) years: cartridge, hose, ten (10) years: spray head. The wearable parts can be purchased as spare parts from Franke or their Kindred Authorized Retailers. Franke warrants the chrome finishes on Kindred faucets will be free of manufacturing defect for ten (10) years; and all other finishes on Kindred faucets will be free of manufacturing defects for five (5) years from the original date of purchase. Faucets purchased prior to 2022 are subject to the warranty in

place at time of purchase.

Kindred Residential Soap Dispensers Limited Warranty:

Franke warrants that Kindred soap dispensers are free from manufacturing defects in material and workmanship for a period of one (1) year from the date of purchase. Such warranty does not cover damage caused by the use of aggressive soaps or chemicals.

Kindred Residential Accessories Limited Warranty:

Franke warrants that Kindred accessories, including, but not limited to bottom grids, shelves, waste kits, colanders, chopping boards are free from manufacturing defects in material and workmanship for a period of one (1) year from the dates of original purchase.

This warranty supersedes all other warranties, expressed or implied. No employee, field sales representatives, or distribution persons are authorized to give any warranties on behalf of Franke Home Solutions North America, LLC or Franke Kindred Canada Limited.

To make an installed product warranty claim please contact Franke at the provided contact information below. All warranty claims must include the following for processing:

1. Proof of purchase from Franke or Kindred Authorized Retailer
2. Original purchaser's name, address (included city, state, zip), email address and phone number
3. Kindred model number
4. Date of installation
5. Description of the defect
6. Photos of the defect

In the US:

Franke Home Solutions
Attn: Warranty Department
800 Aviation Parkway
Smyrna, TN 37167
HS-Warranty.US@Franke.com

In Canada:

Franke Home Solutions
Attn: Warranty Department
1000 Franke Kindred Road
Midland, Ontario L4R 4K9
HS-Warranty.CA@Franke.com

Legal Entities: USA: Franke Home Solutions North America, LLC Canada: Franke Kindred Canada Limited

Terms & Conditions

GENERAL

- Products may only be sold and advertised within North America. Franke hereby expressly prohibits the dealer from soliciting or consummating sales outside of North America without prior written consent.
- Products shall only be sold in their original packaging. Relabeling, repackaging (including the separation of bundled products or the bundling of separate products), and other alterations are not permitted.
- Sale of Franke products on the Internet shall be prohibited unless resellers apply and are approved by Franke Kitchen Systems, LLC, and execute an Authorized Internet Reseller Agreement regulating the manner in which they sell online.

ORDERING

- Once an order has been acknowledged, changes (including additions or cancellations) will be accepted within 48 hours prior to shipping.
- Order acknowledgments are available via email or EDI. An email address must be provided to receive this benefit.
- Standard lead time for shipment of product in stock, inside of Ontario and Quebec, is one to five (1-5) business days from receipt of order. Orders outside Ontario and Quebec is (5-10) business days from receipt of order. * Lead times could vary due to circumstances outside our control*

STANDARD PAYMENT TERMS

- Net 30 days.
- Franke reserves the right to charge interest and an administration fee on late payments.

PRICING

- Please refer to the electronically published price list (EPL). Orders will be priced with the prevailing price at the time the order is placed.
- Prices are subject to change without notice. Franke will attempt to provide reasonable lead time for pricing changes.

CLAIMS / CHARGE BACKS

- Damages/Shortages must be reported within ten (10) days of receipt of merchandise.
- Charge backs will not be accepted without an authorization number (RMA), provided by a National Sales Manager, Rep or Customer Service.

RETURNS

- No returns will be accepted without a return authorization number (RMA).
- Return authorization requests must be submitted through Rep/ National Sales Manager.
- A 25% restocking fee will be charged for ALL returns of saleable product in original condition, not required

- A 40% (or more) restocking fee will be charged for unsaleable product needing re-work. I.e. boxes
- Quality related issues can be returned with no restocking fee. Inspection required prior to shipping.
- No returns will be accepted more than 180 days from original invoice date, unless otherwise approved by NSM.
- No returns will be accepted on discontinued (DWO) or obsolete product.
- Franke reserves the right to decline / refuse returns with reason.



BACK ORDERS

- Back order shipments will match terms in place by individual accounts.
- Back ordered product will be considered an active order unless customer requests cancellation.

FREIGHT

- Pre-paid freight/Free freight allowance (FFA)
 - USD 2,900 is the minimum order value for FFA
 - All product lines, including parts, can be included in freight qualification calculations.
 - All Display and Literature orders will be shipped with pre-paid freight status.
 - Flat Rate Shipping
 - Any order shipping parcel containing standard products will ship for \$25 flat.
 - Orders >150 lbs. are shipping LTL and are charged according to weight/dimension.
 - Orders containing Fireclay sinks are charged USD 150 for up to 2 units and USD 300 for up to 4 units.
 - Other: standard shipping rates apply for Fireclay orders greater than 4 units and any parts only orders.
 - Franke reserves the right to modify these terms at any time.
 - Other freights terms
 - Franke will attempt to fulfill requests to expedite shipping. Customers will be responsible for additional freight charges. Contact Customer Service for all expedited shipping requests.
 - Drop shipment of internet orders is not available. All Internet Sales must be shipped from an Authorized Internet Reseller's location. Drop shipment is offered within 100 miles of customer's place of business, or within customer's state or a bordering state.
- BACK ORDERS**
- Back order shipments will match freight qualifying status of original order.
 - Back ordered product will be considered an active order unless customer requests cancellation.

PRODUCT REFERENCE GUIDE

MODEL	STRAINER BASKET	BOTTOM GRID	BAMBOO CUTTING BOARD	ROLLER MAT	COLANDER	PG	
 BSU1832-9	 1135	 BG531S	 MB517	 RM55S	 C417P	14	
 BSU1832-90W	 1135	 BG5310S	 MB517	 RM55S	 C417P	14	
 BSU1831-9	 1135	 BG529S	 MB517	 RM55S	 C417P	14	
 BSU1825-9	 1135	 BG523S	 MB517	 RM55S	 C417P	15	
 BSU1820-9	 1135	 BG518S	 MB517	 RM55S	 C417P	15	
 BSU1816-9	 1135	 BG514S	 MB517	 RM55S	 C417P	16	
 BSU1812-8	 1135	 BG510S	 MB517		 C417P	16	
 BCU1836R-9	 1135	 BG523S	 BG510S	 MB517	 RM55S	 C417P	16
 BCU1835R-9	 1135	 BG518S	 BG514S	 MB517	 RM55S	 C417P	17
 BCU1831R-9	 1135	 BG518S	 BG510S	 MB517	 RM55S	 C417P	17
 BCU1827R-9	 1135	 BG514S	 BG510S	 MB517	 RM55S	 C417P	18
 BDU1831-9	 1135	 BG514S		 MB517	 RM55S	 C417P	18
 BTU1841-9	 1135	 BG514S	 BG510S	 MB517	 RM55S	 C417P	18

































MODEL	STRAINER BASKET	BOTTOM GRID	BAMBOO CUTTING BOARD	ROLLER MAT	COLANDER	PG
BSL2233-9-4 BSL2233-9-3 BSL2233-9-1	1135	BG531S	MB517	RM55S	C417P	22
BSL2233-9-4OW BSL2233-9-3OW BSL2233-9-1OW	1135	BG5310S	MB517	RM55S	C417P	22
BSL2131-9-4 BSL2131-9-3 BSL2131-9-1	1135	BG529S	MB517	RM55S	C417P	22
BSL2225-9-4 BSL2225-9-3 BSL2225-9-1	1135	BG523S	MB517	RM55S	C417P	23
BSL2125-9-4 BSL2125-9-3 BSL2125-9-1	1135	BG523S	MB517	RM55S	C417P	23
BSL2120-9-4 BSL2120-9-3 BSL2120-9-1	1135	BG518S	MB517	RM55S	C417P	24
BSL2116-9-3 BSL2116-9-1	1135	BG514S	MB517	RM55S	C417P	24
BCL2131R-9-4 BCL2131R-9-3 BCL2131R-9-1	1135	BG518S BG510S	MB517	RM55S	C417P	24
BCL2127R-9-4 BCL2127R-9-3 BCL2127R-9-1	1135	BG514S BG510S	MB517	RM55S	C417P	25
BDL2233-9-4 BDL2233-9-3 BDL2233-9-1	1135	BG515S	MB517	RM55S	C417P	25
BDL2131-9-4 BDL2131-9-3 BDL2131-9-1	1135	BG514S	MB517	RM55S	C417P	26

Brookmore Topmount / Drop In

MODEL	STRAINER BASKET	BOTTOM GRID	BAMBOO CUTTING BOARD	ROLLER MAT OR DRAINER BASKET	COLANDER	PG
BSL2225-ADA-1	1135	BG523S	MB517	RM55S	C417P	29
BSL2233-ADA-1	1135	BG531S	MB517	RM55S	C417P	29
QSUA1933-8	1135	BGA3117S	112.0654.749	DBR10S		34
QSUA1831-8	1135	BG240S	112.0654.749	DBR10S		34
QSUA1925-8	1135	BGA2317S	112.0654.749	DBR10S		34
QSUA1922-8	1135	BG14S	112.0654.749	DBR10S		35
QSUA1917-8	1135	BGA1517S	112.0654.749	DBR10S		35
QSU1813-7	1135	BG35S	112.0654.749			36
QSUA1820-8	1135	BG11S	112.0654.749	DBR10S		36
QSUA1616-6	1135		112.0654.749			36
QSUA1816-8	1135	BG10S	112.0654.749	DBR10S		37
QSU1315-6	1135		112.0654.749			37

Brookmore ADA

Steel Queen Undermount

MODEL	STRAINER BASKET	BOTTOM GRID	BAMBOO CUTTING BOARD	COLANDER	DRAINER BASKET	PG
 QSU1113-6N	 1135		 112.0654.749			38
 QCU1933R-9N	 1135	  BGA1217S BGA1817S	 112.0654.749		 DBR10S	38
 QCUA1933R-8N	 1135	  BGA1217S BGA1817S	 112.0654.749		 DBR10S	38
 QCUA1831R-8N QCUA1831L-8N	 1135	  BG11S BG13S	 112.0654.749	 CA1W Included	 DBR10S	39
 QCUA1827R-8N QCUA1827L-8N	 1135	  BG10S BG13S	 112.0654.749	 CA1W Included	 DBR10S	39
 QCU2031R-9N	 1135	  BG30S BG35S	 112.0654.749			40
 QDUA1933-8N	 1135	 BGA1517S	 112.0654.749		 DBR10S	40
 QDUA1831-8N	 1135	 BG10S	 112.0654.749		 DBR10S	40







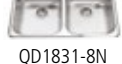











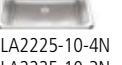

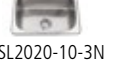





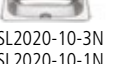

Steel Queen Undermount

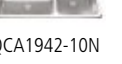
Steel Queen Topmount / Drop In

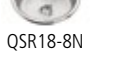
MODEL	STRAINER BASKET	BOTTOM GRID	COLANDER	DRAINER BASKET	PG
 QSLA2233-8-4N QSLA2233-8-3N QSLA2233-8-1N	 1135	 BGA3117S		 DBR10S	44
 QSLA2031-8-4N QSLA2031-8-3N QSLA2031-8-1N	 1135	 BG240S		 DBR10S	44
 QSLA2225-8-4N QSLA2225-8-3N QSLA2225-8-1N	 1135	 BGA2317S		 DBR10S	44
 QSLA2217-8-3N QSLA2217-8-1N	 1135	 BGA1517S		 DBR10S	45
 QSL2020-8-3N QSL2020-8-1N	 1135	 BG11S		 DBR10S	45
 QSA1820-8N	 1135	 BG11S	 112.0654.749	 DBR10S	46
 QSA1816-8N	 1135	 BG10S	 112.0654.749	 DBR10S	46
 QSL2020-7-3N QSL2020-7-1N	 1135	 BG11S		 DBR10S	46

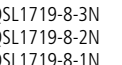

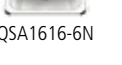



MODEL	STRAINER BASKET	BOTTOM GRID	COLANDER	DRAINER BASKET	PG
 QCLA2031R-8-3N QCLA2031R-8-1N QCLA2031L-8-3N QCLA2031L-8-1N	 1135	 BG11S	 CA1W Included	 DBR10S	47
 QDLA2233-8-4N QDLA2233-8-3N QDLA2233-8-1N	 1135	 BGA1517S		 DBR10S	47
 QCLA2027R-8-3N QCLA2027R-8-1N QCLA2027L-8-3N QCLA2027L-8-1N	 1135	 BG10S	 CA1W Included	 DBR10S	48
 QDC2031R-8-1N	 1135	 BG30S			48
 QDL2031-8-4N QDL2031-8-3N QDL2031-8-1N	 1135	 BG10S		 DBR10S	48
 QCMA1826-7-3N QCMA1826-7-1N	 1135	 BG10S	 112.0654.749	 DBR10S	49
 QD1831-8N	 1135	 BG10S	 112.0654.749	 DBR10S	49
 QDL2031-7-4N QDL2031-7-3N QDL2031-7-1N	 1135	 BG10S		 DBR10S	50

Steel Queen Topmount / Drop In

MODEL	STRAINER BASKET	BOTTOM GRID	DRAINER BASKET	PG
 QSLF2020-12-3 QSLF2020-12-1	 1135 Included		 DBR10S	54
 QSLF2020-10-3 QSLF2020-10-1	 1135 Included		 DBR10S	54
 QSL2225-12-3N QSL2225-12-1N	 1135			54
 QSLA2225-10-4N QSLA2225-10-3N QSLA2225-10-1N	 1135	 BGA2317S		55
 QSL2020-10-3N QSL2020-10-1N	 1135	 BG110S		55
 QSU1820-10N	 1135	 BG110S		56
 QS1820-10N	 1135	 BG110S		56
 RSL2020-10-3N RSL2020-10-1N	 1135	 BG110S		56
 QCA1942-10N	 1135	 BGA2317S BGA1517S		57
 QSR18-8N	 1135			58
 QSL1719-8-3N QSL1719-8-2N QSL1719-8-1N	 1135			58
 QSA1616-6N	 1135			58

Steel Queen Utility - Laundry

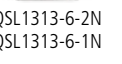

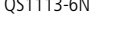





























Steel Queen Utility - Hospitality

MODEL	STRAINER BASKET	PG
 QSL1515-6-2N QSL1515-6-1N	 1135	59
 QS1315-6N	 1135	59
 QSL1313-6-2N QSL1313-6-1N	 1135	60
 QS1113-6N	 1135	60



















Steel Queen Utility - Hospitality













MODEL	STRAINER BASKET	BOTTOM GRID	DRAINER BASKET	ROLLER MAT	PG
 CSLA1515-6-2CBN					66
 CSLA2522-8-4CBN CSLA2522-8-3CBN CSLA2522-8-1CBN	 4010856	 BG2317R			66
 CSLA2522-7-4N CSLA2522-7-3N CSLA2522-7-1N	 4010856	 BG2317C			66
 CSLA2522-6-4N CSLA2522-6-3N CSLA2522-6-1N	 4010856	 BG2317C			67
 FCDLA3322-8-4CBN FCDLA3322-8-3CBN FCDLA3322-8-1CBN	 4010856	 BG1715R			67
 CDLA3322-8-4CBN CDLA3322-8-3CBN CDLA3322-8-1CBN	 4010856	 BG1715R			68
 CDLA3322-7-4N CDLA3322-7-3N CDLA3322-7-1N	 4010856	 BG1715C			68
 CDLA3322-6-4N CDLA3322-6-3N CDLA3322-6-1N	 4010856	 BG1715C			68
 RDLA3319-6-4CBN	 4010856				69

Creemore Topmount / Drop In

MODEL	STRAINER BASKET	BOTTOM GRID	DRAINER BASKET	PG
 NS1930U-9N	 1135	 BG90S	 DBR10S	74
 NS1925U-9N	 1135	 BG80S	 DBR10S	74
 NS1820UA-9N	 1135	 BG11S		74
 RSU1820-7N	 1135	 BG11S		75
 NS1813U-7N	 1135	 BG35S		75
 NDCX2132RU-9N	 1135	 BG30S	 BG35S	76
 ND1831UA-9N	 1135	 BG10S	 DBR10S	76
 NDC1827RU-9N	 1135	 BG10S	 BG13S	76
 RDU1831-7N	 1135	 BG10S	 DBR10S	77

Reginox Undermount

	MODEL	STRAINER BASKET	BOTTOM GRID	DRAINER BASKET	PG
Reginox Topmount / Drop In	 RSL2020-3N RSL2020-1N	 1135	 BG110S		80
	 RCL2027R-3N RCL2027R-1N	 1135	 BG10S	 DBR10S	80
	 RDL2031-3N RDL2031-1N	 1135	 BG10S	 DBR10S	81
Reginox ADA	 RSU1829-55N	 1135			84
	 RSU1925-55N	 1135			84
	 RSLA2522-55-4N RSLA2522-55-3N RSLA3322-55-1N	 1135			84
	 RDLA3322-55-4N RDLA3322-55-3N RDLA3322-55-1N	 1135			85

	MODEL	STRAINER BASKET	BOTTOM GRID	BAMBOO CUTTING BOARD	COLANDER	PG
Urban Granite Undermount	 MGS2031U-9N	 1135	 BG410S	 BB10	 C417P	90
	 MGS2022U-9N	 1135	 BG400S	 BB10	 C417P	90
	 MGC2034U-9N	 1135	  BG450S BG440S	 BB10	 C417P	90
	 MGC2031U-9N	 1135	  BG430S BG440S	 BB10	 C417P	91
	 MGSM2031-9N	 1135	 BG410S	 BB10	 C417P	94
	 MGSM2022-9N	 1135	 BG400S	 BB10	 C417P	94
	 MGCM2034-9N	 1135	  BG450S BG440S		 C417P	94
	 MGCM2031-9N	 1135	  BG430S BG440S	 BB10	 C417P	95



Pictured: MGC2031U-9MBKN

MINIMUM CABINET SIZE

18"



BSU1812-8N
Page 16



NS1813U-7N
Page 75



QSU1113-6N
Page 38



QSU1315-6N
Page 37



BSL2116-9-3N
BSL2116-9-1N
Page 24



CSLA1515-6-2CBN
Page 66



QSU1113-6N
Page 60



QSU1315-6N
Page 59



QSA1616-6N
Page 58



QSA1816-8N
Page 46



QSL1313-6-2N
QSL1313-6-1N
Page 60



QSL1515-6-2N
QSL1515-6-1N
Page 59

21"



BSU1816-9N
Page 16



QSL1719-8-3N
QSL1719-8-2N
QSL1719-8-1N
Page 58



QSLA2217-8-3N
QSLA2217-8-1N
Page 45



QSR18-8N
Page 58



QSU1813-7N
Page 36



QSU1820-10N
Page 56



QSUA1616-6N
Page 36



QSUA1816-8N
Page 37



QSUA1917-8N
Page 35

24"



BSL2120-9-4N
BSL2120-9-3N
BSL2120-9-1N
Page 24



BSU1820-9N
Page 15



MGSM2022-9N
Page 94



NS1820UA-9N
Page 74



QS1820-10N
Page 56



QSA1820-8N
Page 46



QSL2020-10-3N
QSL2020-10-1N
Page 55



QSL2020-7-3N
QSL2020-7-1N
Page 46



QSL2020-8-3N
QSL2020-8-1N
Page 45



QSLF2020-12-3
QSLF2020-12-1
Page 54



QSLF2020-10-3
QSLF2020-10-1
Page 54



QSUA1820-8N
Page 36



RSL2020-3N
RSL2020-1N
Page 80



RSL2020-10-3N
RSL2020-10-1N
Page 56



RSU1820-7N
Page 75

27"

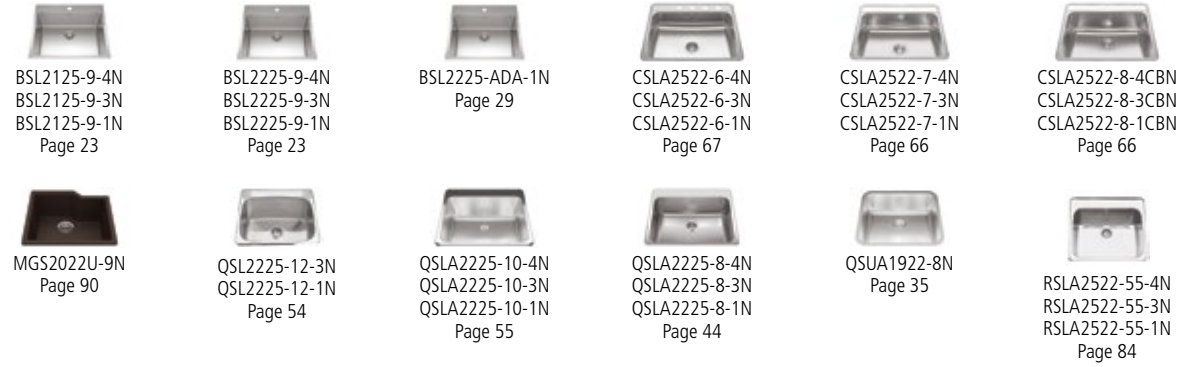

30"



33"



36"



39"



45"

